

# SIDELITE U-CHANNEL

**PRL** GLASS  
SYSTEMS  
INC.

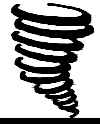

\* FINISHES AVAILABLE :  
# 8 POLISHED & # 4 SATIN  
STAINLESS  
US3 POLISHED & US4 SATIN  
BRASS ( NON LACQUER  
COATED)  
US10B  
ANODIZED PAINTED

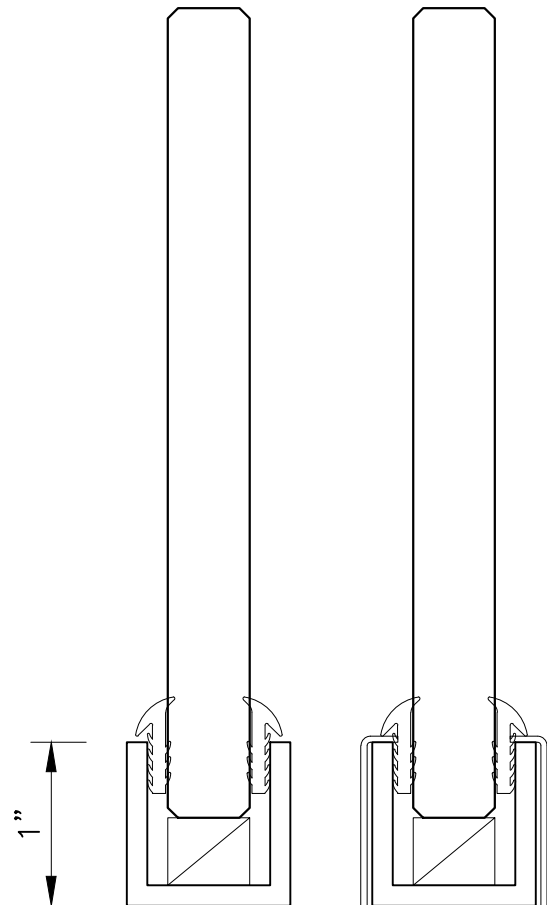
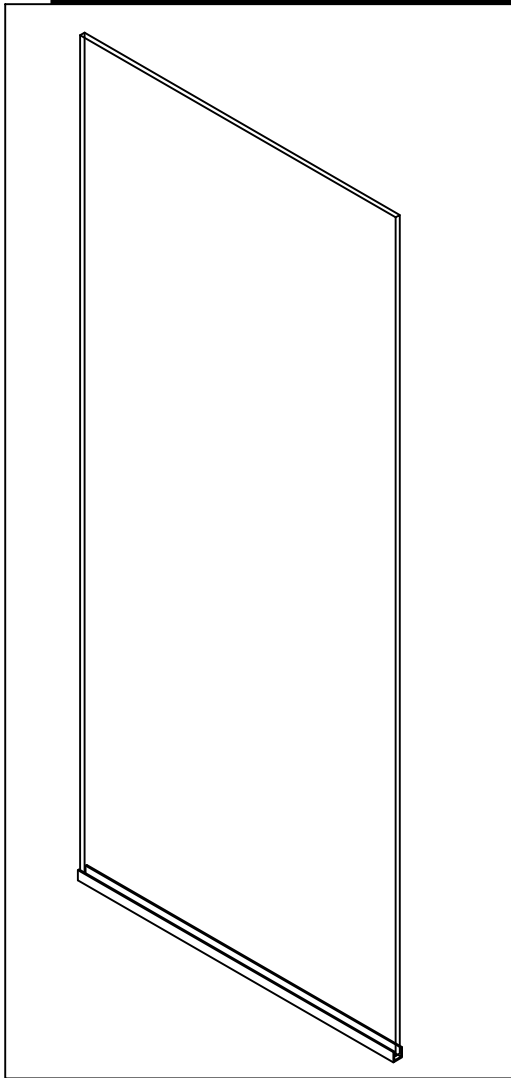

1"

1 X 1 U-CHANNEL

# SIDELITE U-CHANNEL

**PRL** GLASS  
SYSTEMS  
INC.



\* FINISHES AVAILABLE :  
# 8 POLISHED & # 4 SATIN  
STAINLESS  
US3 POLISHED & US4 SATIN  
BRASS ( NON LACQUER  
COATED)  
US10B  
ANODIZED PAINTED

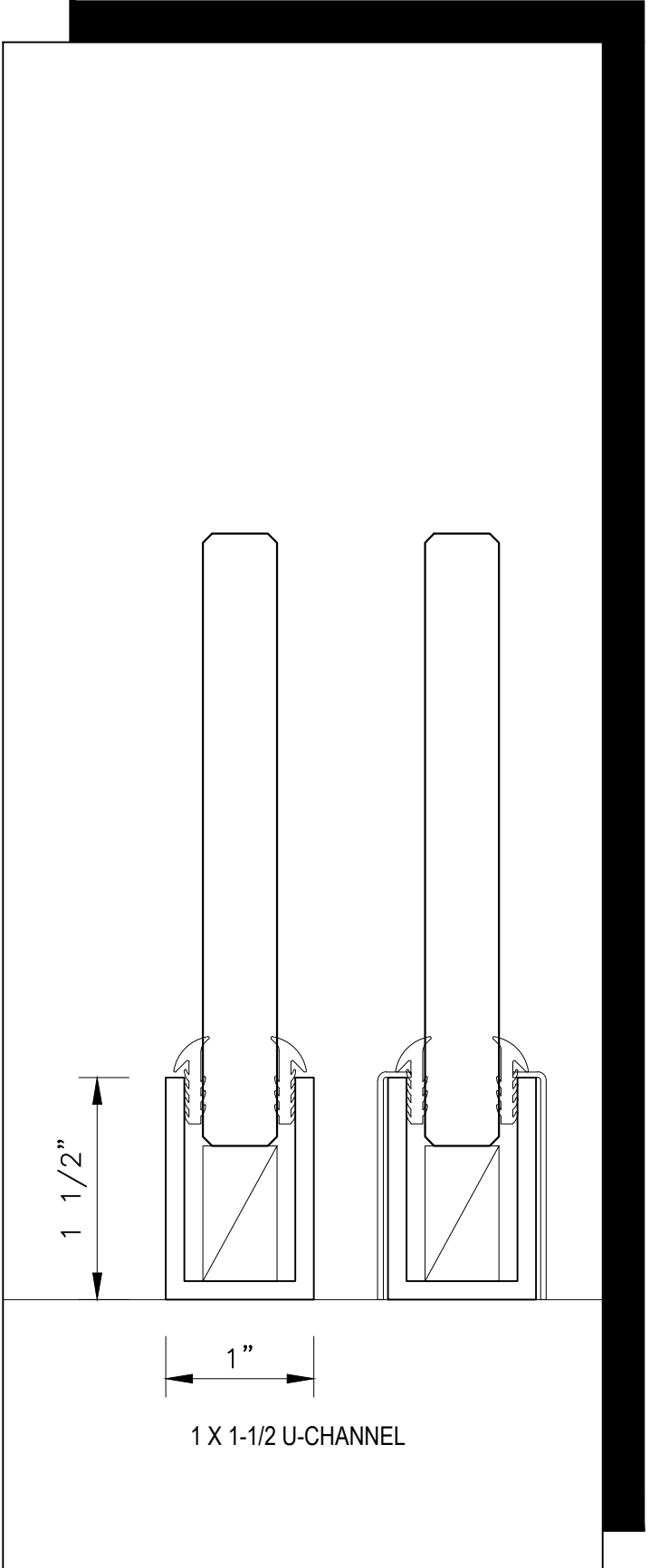
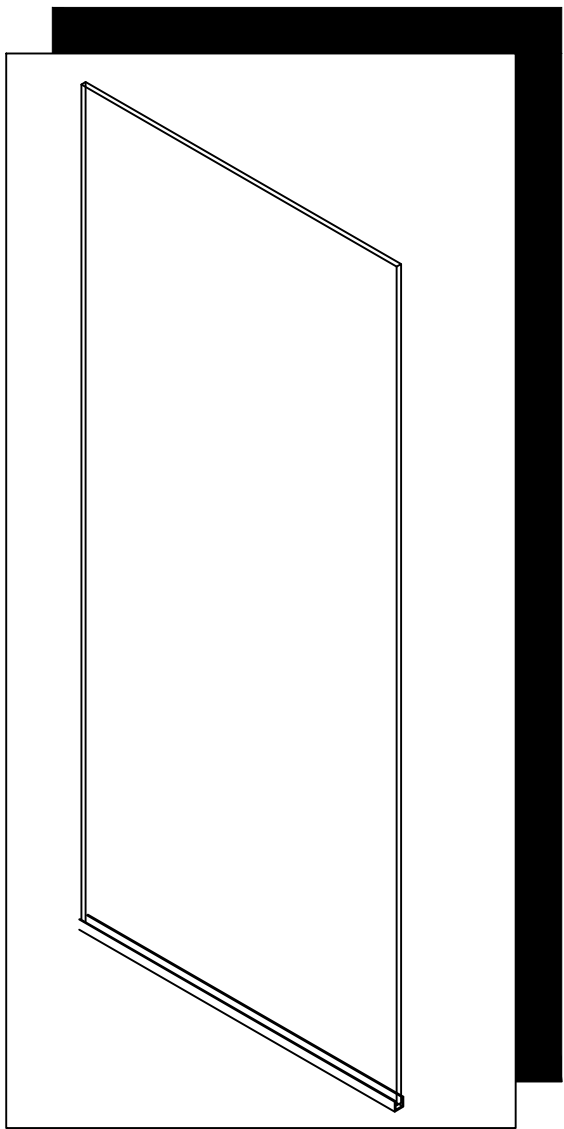

# SIDELITE U-CHANNEL

**PRL** GLASS  
SYSTEMS  
INC.



\* FINISHES AVAILABLE :  
# 8 POLISHED & # 4 SATIN  
STAINLESS  
US3 POLISHED & US4 SATIN  
BRASS ( NON LACQUER  
COATED)  
US10B  
ANODIZED PAINTED

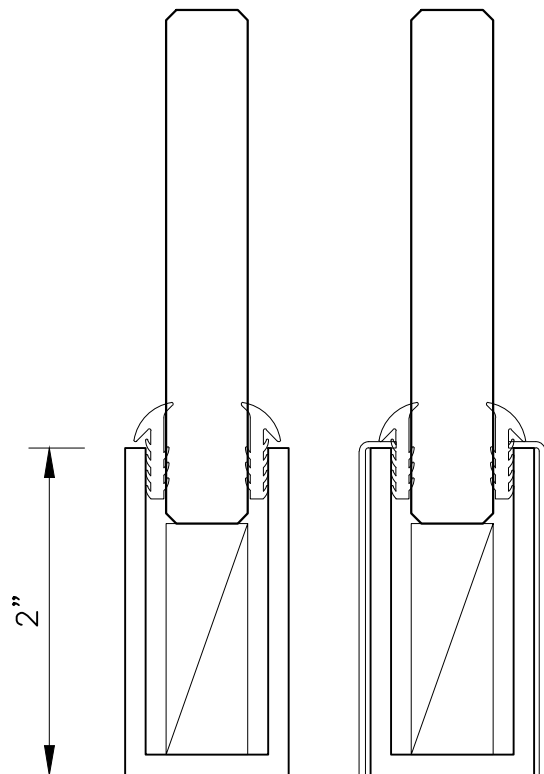
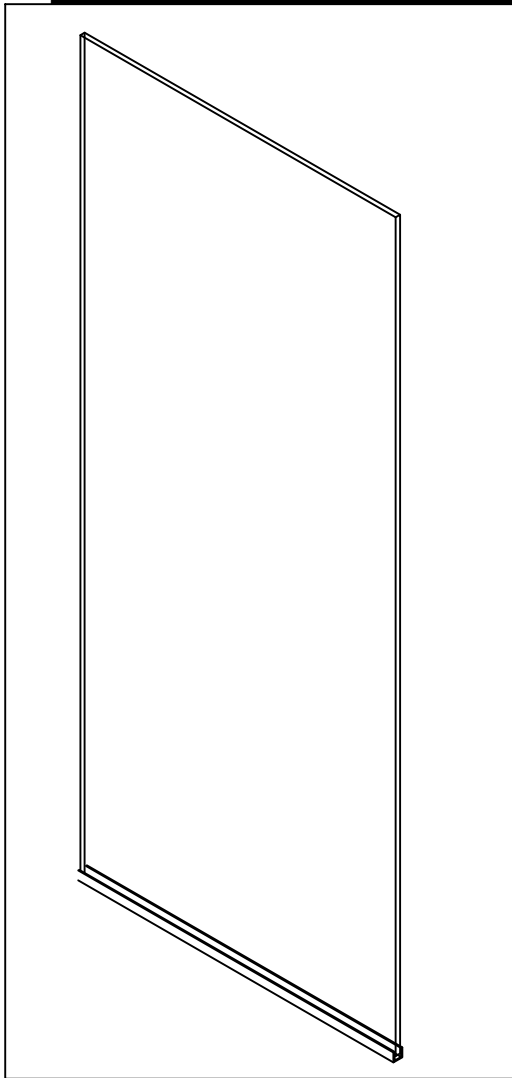

1"

1 X 2 U-CHANNEL

# SIDELITE U-CHANNEL

**PRL** GLASS  
SYSTEMS  
INC.



\* FINISHES AVAILABLE :  
# 8 POLISHED & # 4 SATIN  
STAINLESS  
US3 POLISHED & US4 SATIN  
BRASS ( NON LACQUER  
COATED)  
US10B  
ANODIZED PAINTED

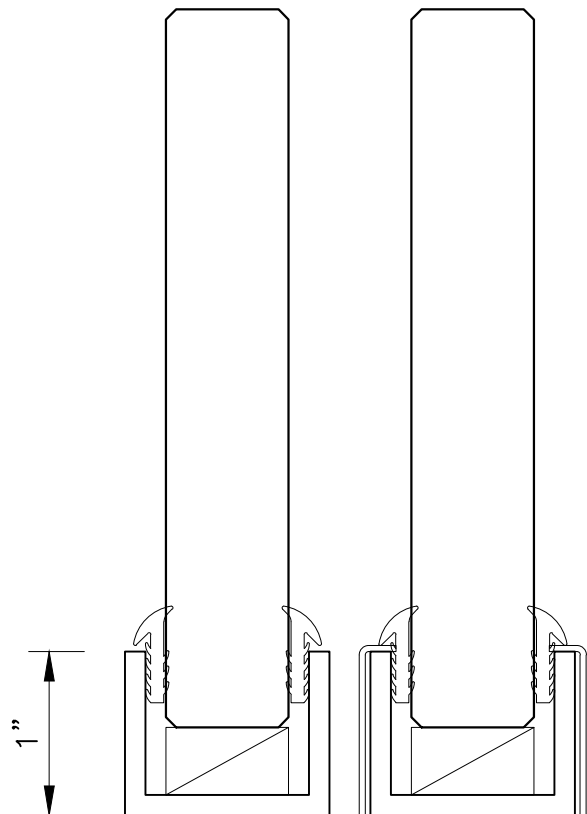
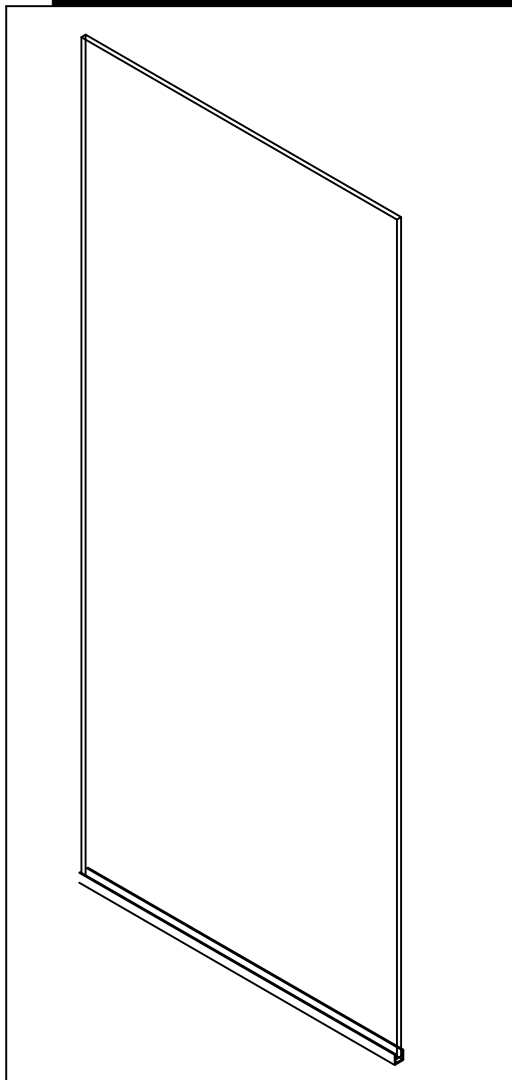

1 1/4"

1-1/4 X 1-3/4 U-CHANNEL

# SIDELITE U-CHANNEL

**PRL** GLASS  
SYSTEMS  
INC.

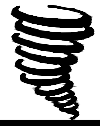

\* FINISHES AVAILABLE :  
# 8 POLISHED & # 4 SATIN  
STAINLESS  
US3 POLISHED & US4 SATIN  
BRASS ( NON LACQUER  
COATED)  
US10B  
ANODIZED PAINTED

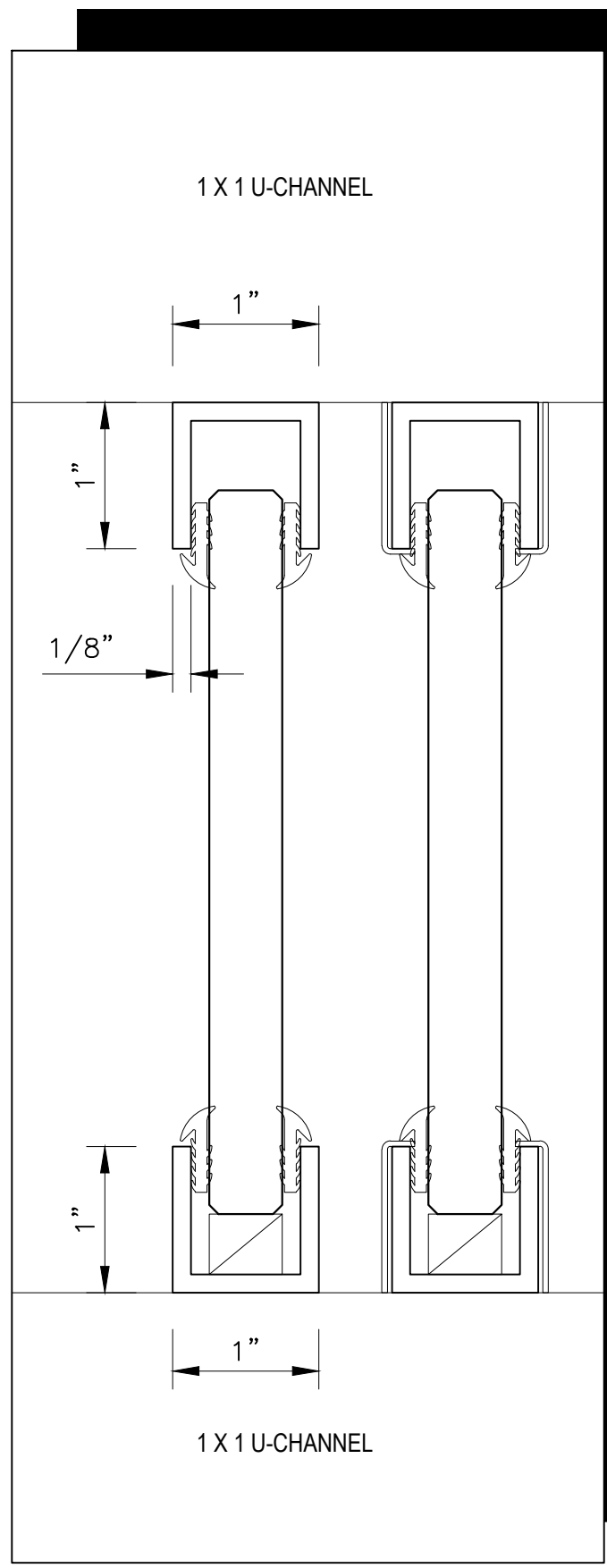
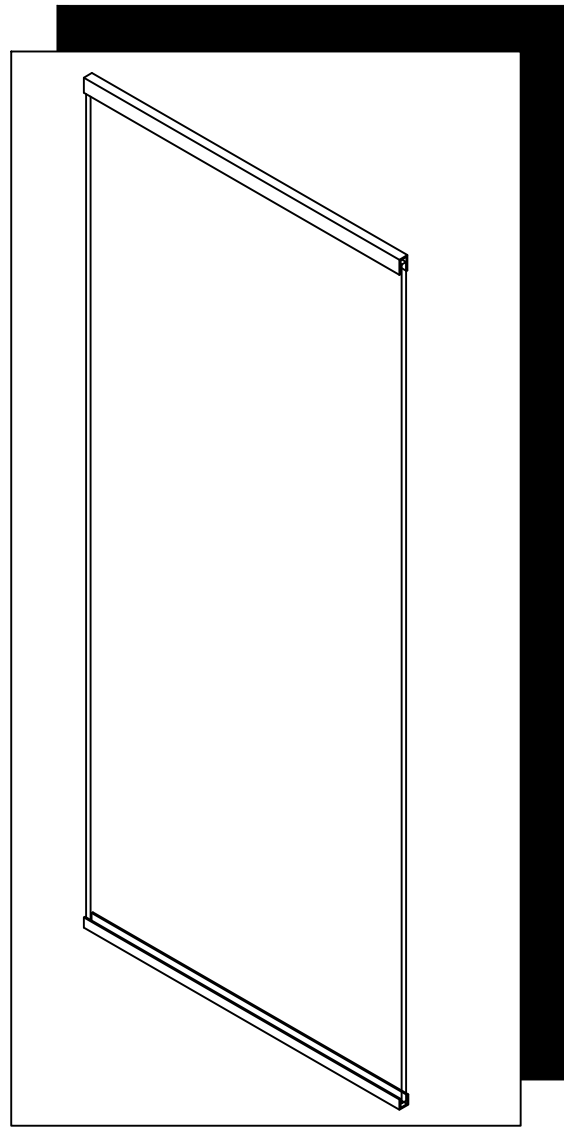

# SIDELITE U-CHANNEL

**PRL** GLASS  
SYSTEMS  
INC.



\* FINISHES AVAILABLE :  
# 8 POLISHED & # 4 SATIN  
STAINLESS  
US3 POLISHED & US4 SATIN  
BRASS ( NON LACQUER  
COATED)  
US10B  
ANODIZED PAINTED

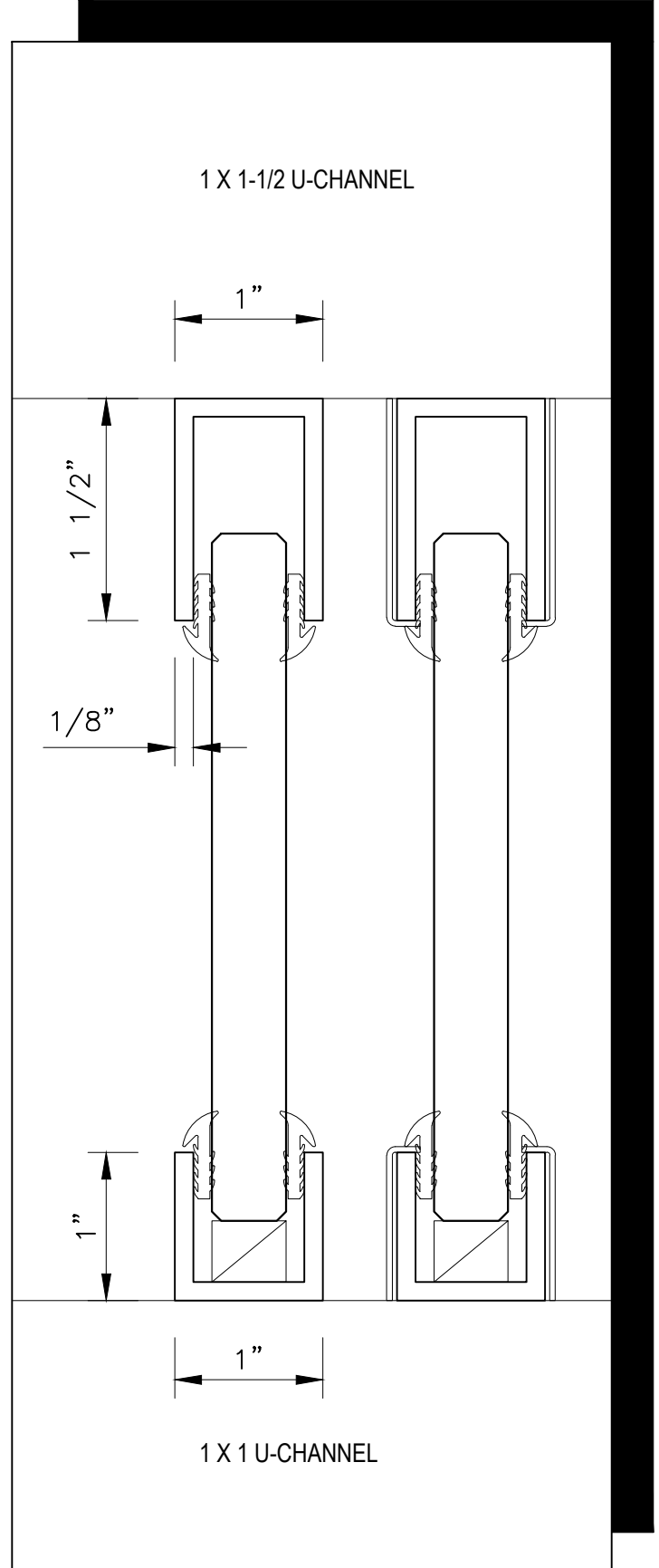
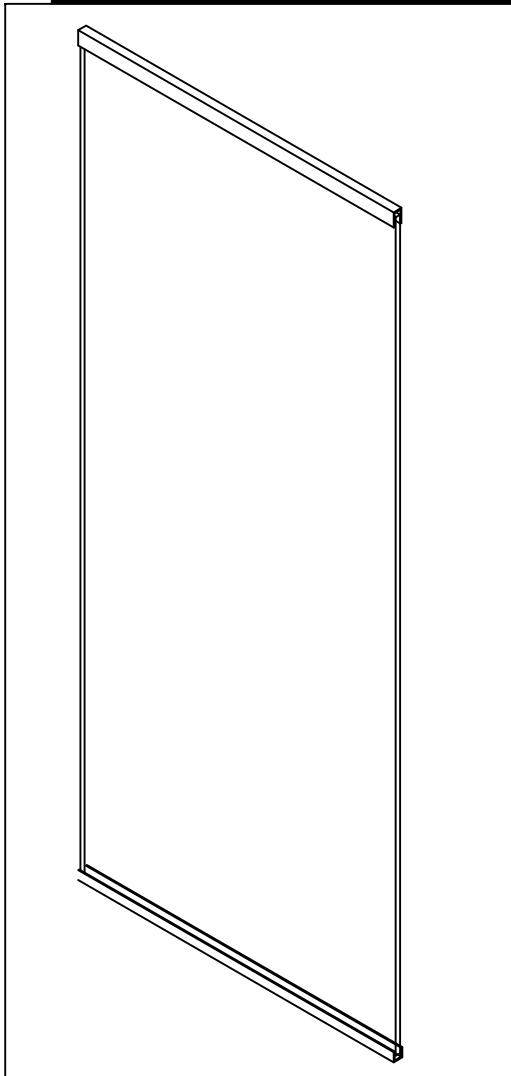

# SIDELITE U-CHANNEL

**PRL** GLASS  
SYSTEMS  
INC.



\* FINISHES AVAILABLE :  
# 8 POLISHED & # 4 SATIN  
STAINLESS  
US3 POLISHED & US4 SATIN  
BRASS ( NON LACQUER  
COATED)  
US10B  
ANODIZED PAINTED

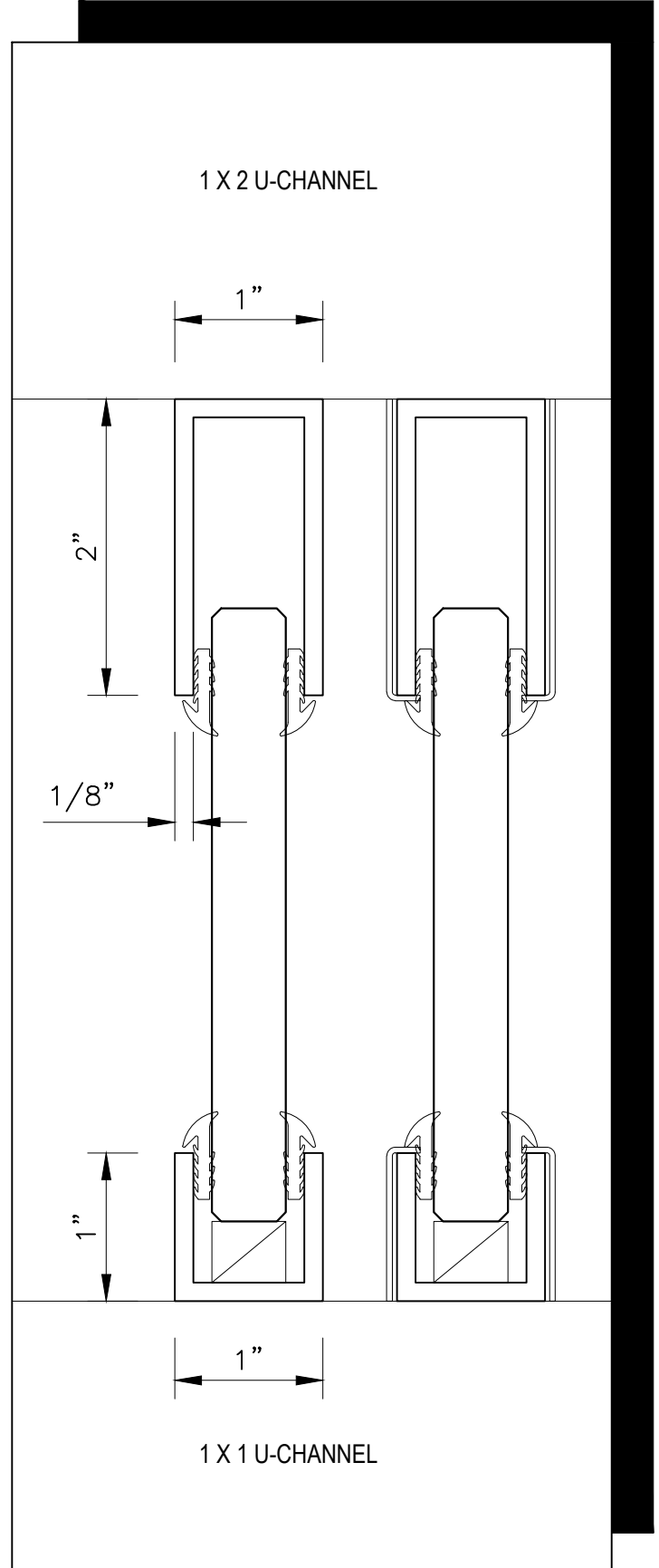
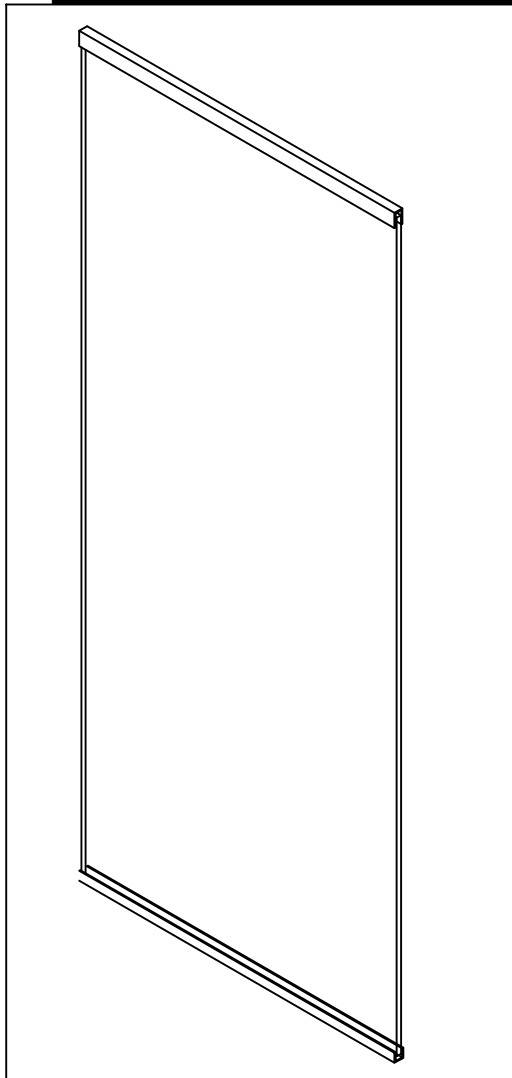

# SIDELITE U-CHANNEL

**PRL** GLASS  
SYSTEMS  
INC.

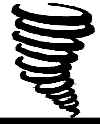

\* FINISHES AVAILABLE :  
# 8 POLISHED & # 4 SATIN  
STAINLESS  
US3 POLISHED & US4 SATIN  
BRASS ( NON LACQUER  
COATED)  
US10B  
ANODIZED PAINTED

