

F-STYLE ALL GLASS DOORS



CONFIGURATIONS



SINGLE DOOR

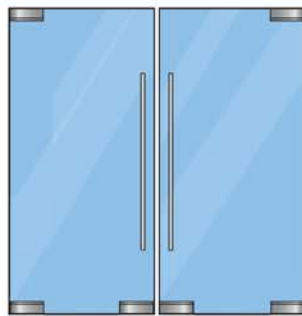

DOUBLE DOOR



AVAILABLE IN
Dry & Wet Glazing
Method



Patch Rails / Patch Fittings



Overhead Closer (OHC)
& Standard Bottom pivot



Floor Closers & Top Walking
Beam Pivot

PATCH RAILS

PATCH FITTINGS / RAILS

PATCH FITTINGS

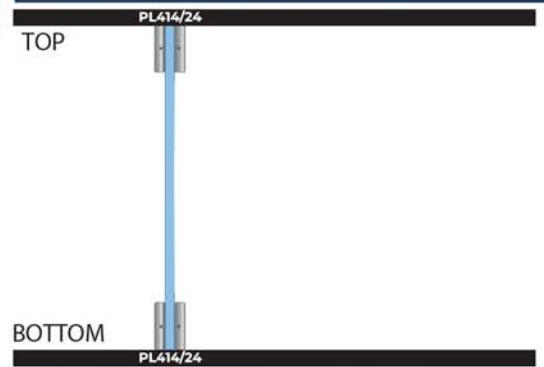
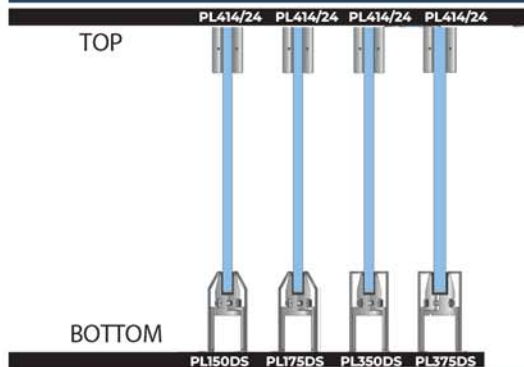
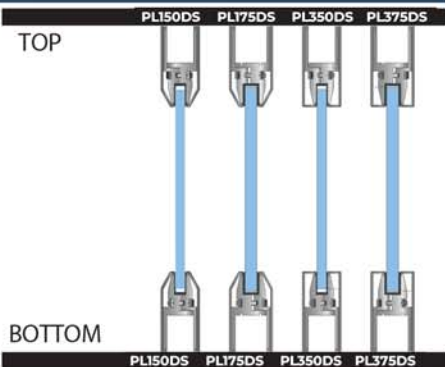

F-STYLE ALL GLASS DOORS

1.1 PATCHES

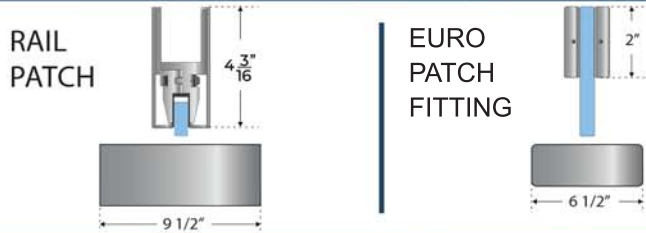

1.2 PATCH RAILS

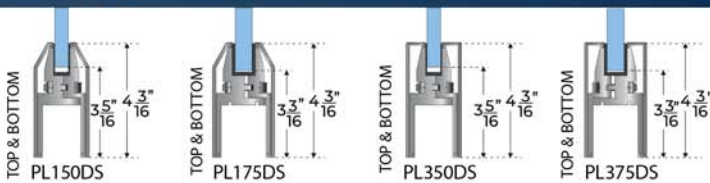

1.2 PATCH FITTING

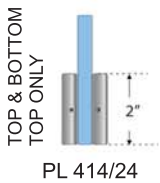

2 GLASS THICKNESS | GLAZING TYPE

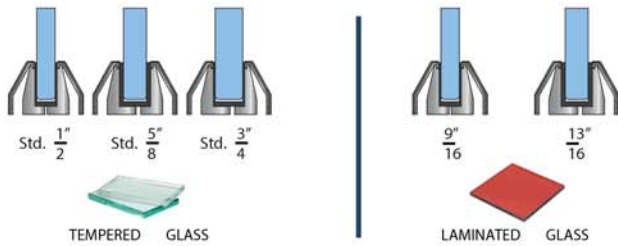

*Consult PRL on colors available based on thickness | *Consult PRL on colors & textures available

4 LOCKS



3 HANDLES

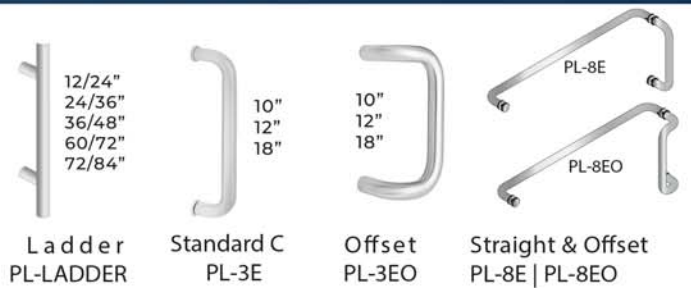

5 CLOSERS

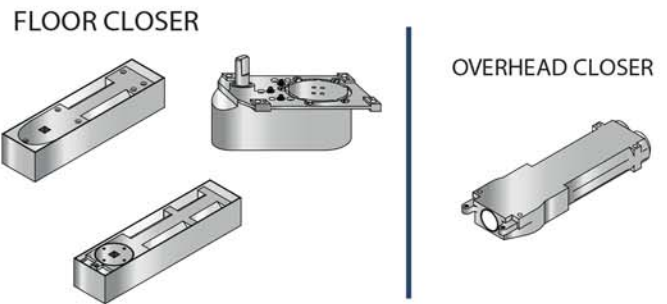

*Consult with PRL regarding which model is best suited for the door's weight

AVAILABLE FINISHES

