

IMPORTANT DESIGN NOTE: ALL DESIGNS, ARRANGEMENTS AND PLANS INDICATED OR REPRESENTED BY THESE DRAWINGS ARE OWNED BY AND THE PROPERTY OF PRL GLASS SYSTEMS INC. NO PART THEREOF SHALL BE REPRODUCED, COPIED, ADAPTED, DISTRIBUTED TO OTHERS, PUBLISHED, SOLD OR OTHERWISE USED WITHOUT THE PRIOR WRITTEN CONSENT OF AND APPROPRIATE COMPENSATION TO PRL GLASS SYSTEMS INC. COPYRIGHT ©

THIS DRAWING IS NOT TO SCALE IF NOT PRINTED ON 24" X 36" PAPER

ARCHITECT OF RECORD'S APPROVAL

---

STRUCTURAL ENGINEER OF RECORD'S APPROVAL

---

STRUCTURAL ENGINEER'S APPROVAL

---

GENERAL CONTRACTOR'S APPROVAL

---

REVISIONS	BY
△	
△	
△	
△	
△	
△	

---

job name  
 job name  
 job name  
 address

---

GENERAL CONTRACTOR: XXXXXXXXXXXX ARCHITECT: XXXXXXXXXXXX

---

DATE: April, 17, 2014  
 SCALE: 1"=X'-X"  
 DRAWN: P  
 JOB: XXXXXXXX  
 SHEET:

**PRL** GLASS SYSTEMS INC.

Telephone : (877) 775-25856      251 Mason Way  
 Fax No. : (626) 968-95256      City of industry, C.A.  
 www.prl.glass.com      www.prlaluminum.com

## Max Slider: Sliding Glass Door - Medium Stile - MS / MS / MS

### Sliding Door / Fixed Panel ( XXO )

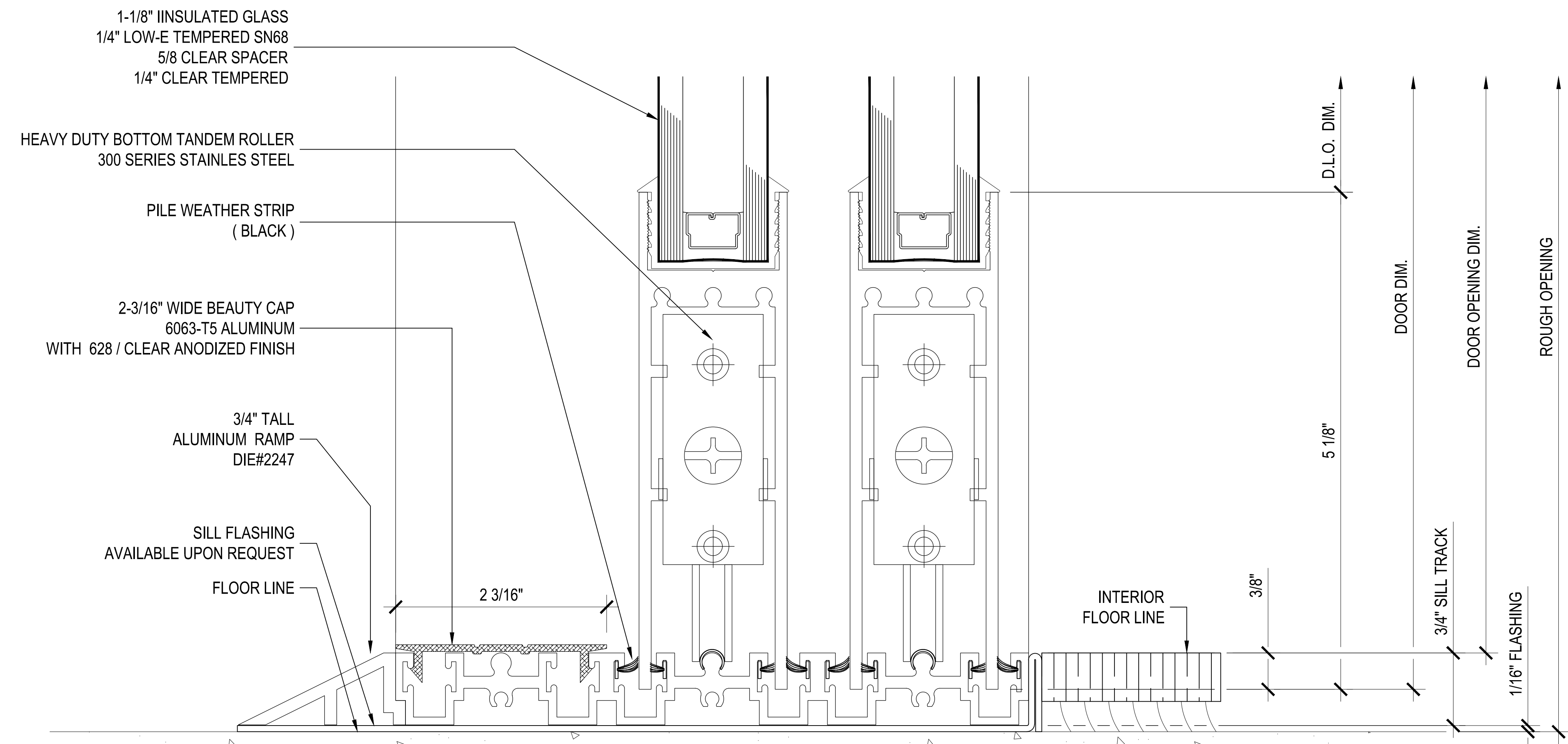
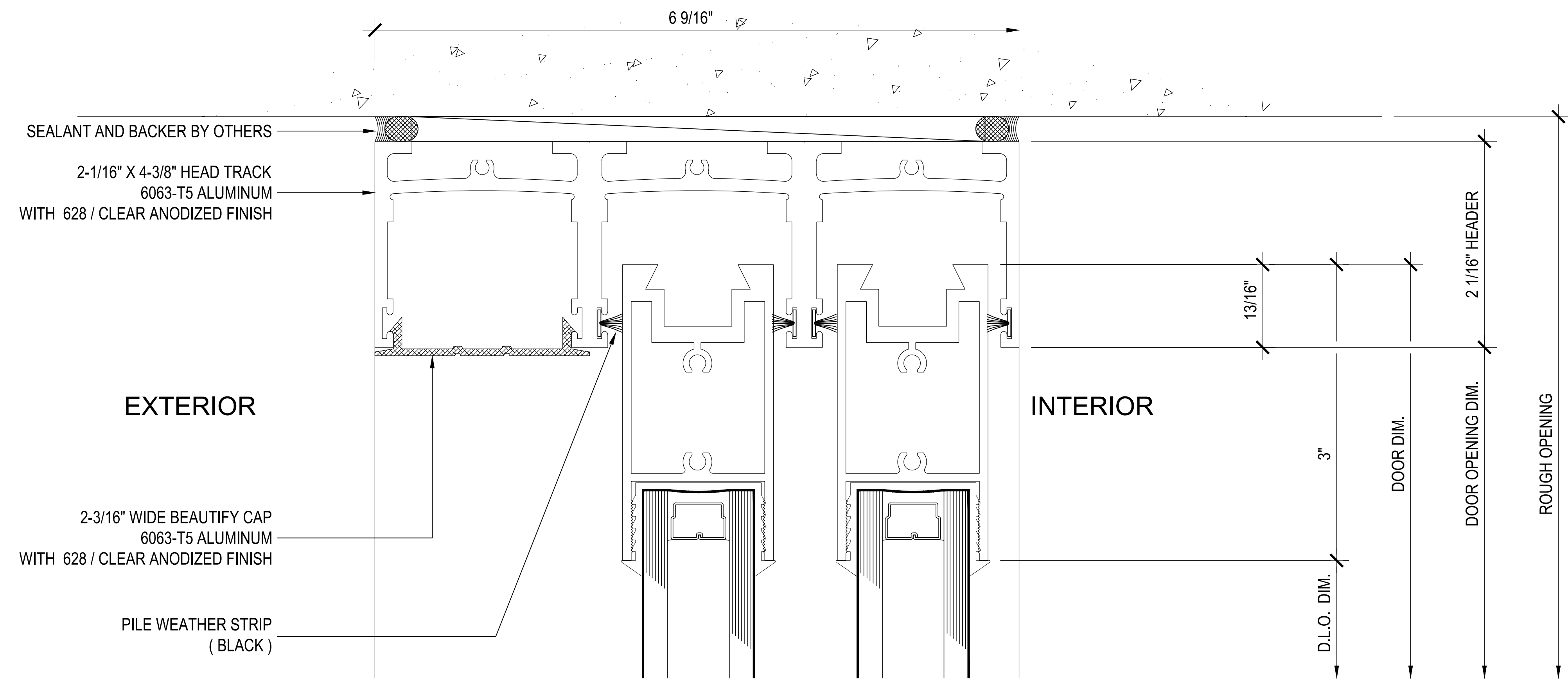

**C**

**Section @ (Slider)**

**Max-Slider Sliding Glass Door (XXO)**

IMPORTANT DESIGN NOTE: THESE DRAWINGS ARE OWNED BY AND THE PROPERTY OF PRL GLASS SYSTEMS INC. NO PART THEREOF SHALL BE REPRODUCED, COPIED, ADAPTED, DISTRIBUTED TO OTHERS, PUBLISHED, SOLD OR OTHERWISE USED WITHOUT THE PRIOR WRITTEN CONSENT OF AND APPROPRIATE COMPENSATION TO PRL GLASS SYSTEMS INC. COPYRIGHT ©

THE DRAWING IS NOT TO SCALE IF NOT PRINTED ON PAPER

ARCHITECT OF RECORD'S APPROVAL

STRUCTURAL ENGINEER OF RECORD'S APPROVAL

STRUCTURAL ENGINEER'S APPROVAL

GENERAL CONTRACTOR'S APPROVAL

REVISIONS	BY

job name  
job name  
job name  
address

GENERAL CONTRACTOR: XXXXXXXX ARCHITECT: XXXXXXXX

DATE: March, 21, 2014  
SCALE: XXXXX  
DRAWN: P  
JOB: XXXXXXXX  
SHEET

2.01

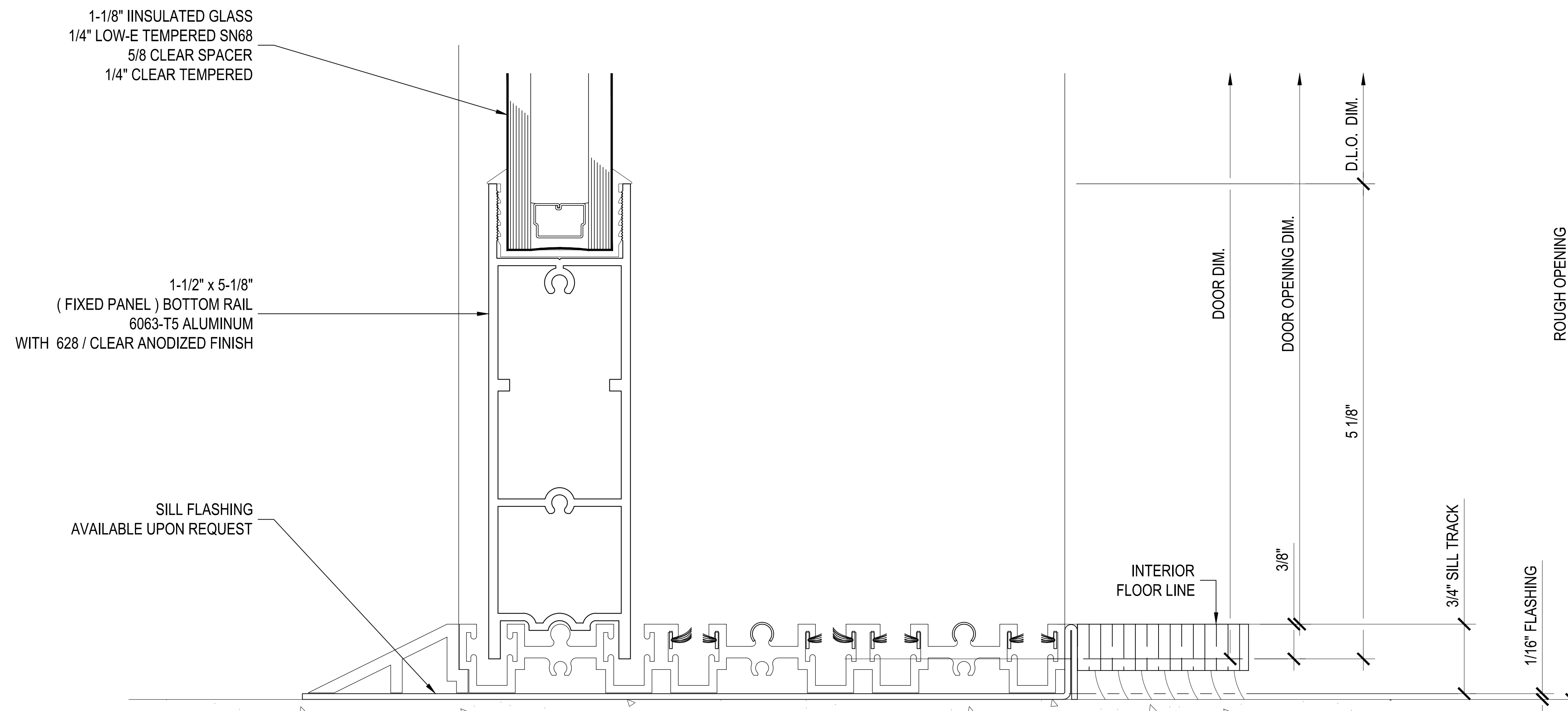
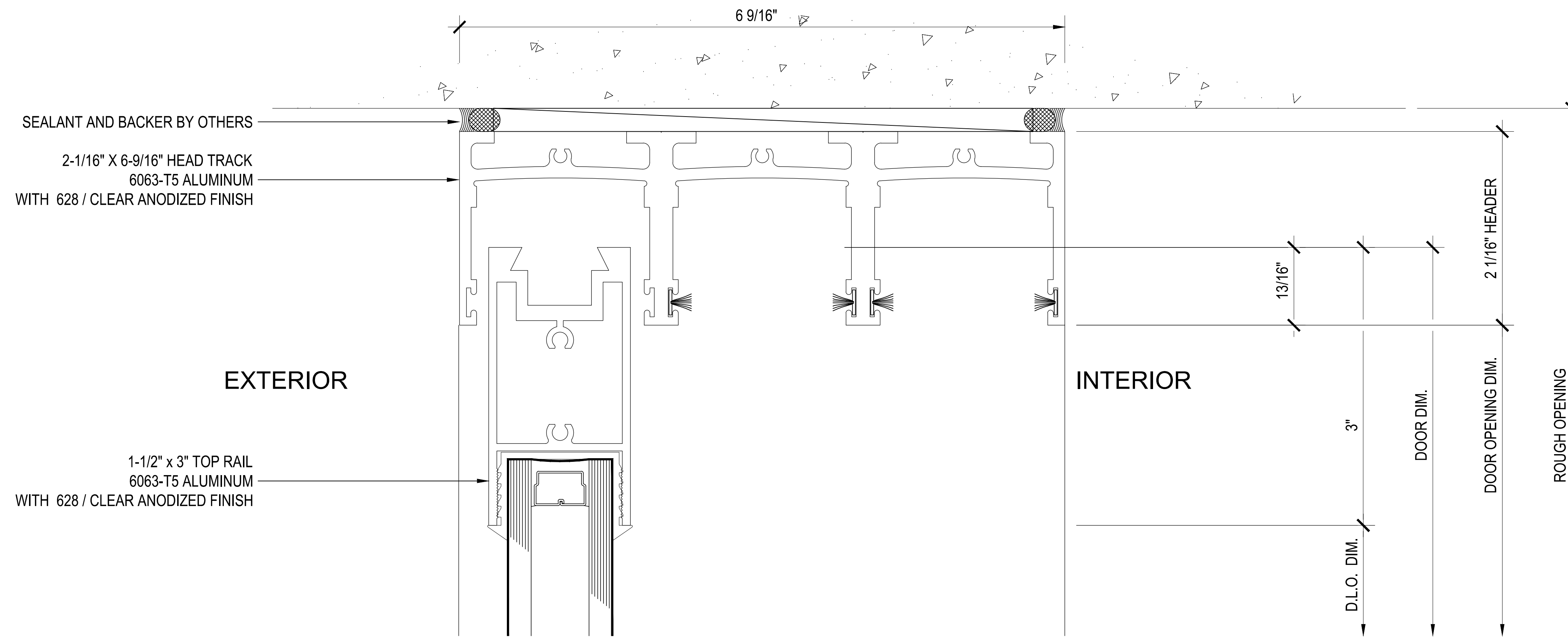

**B** Section @ (Fixed)  
Max-Slider Sliding Glass Door (XXO)

IMPORTANT DESIGN NOTE: ALL IDEAS, DESIGNS, ARRANGEMENTS AND PLANS INDICATED OR REPRESENTED BY THESE DRAWINGS ARE OWNED BY AND THE PROPERTY OF PRL GLASS SYSTEMS INC. NO PART THEREOF SHALL BE REPRODUCED, COPIED, ADAPTED, DISTRIBUTED TO OTHERS, PUBLISHED, SOLD OR OTHERWISE USED WITHOUT THE PRIOR WRITTEN CONSENT OF PRL GLASS SYSTEMS INC. COPYRIGHT ©

ARCHITECT OF RECORD'S APPROVAL

STRUCTURAL ENGINEER OF RECORD'S APPROVAL

STRUCTURAL ENGINEER'S APPROVAL

GENERAL CONTRACTOR'S APPROVAL

REVISIONS	BY

job name  
job name  
job name  
address

GENERAL CONTRACTOR: XXXXXXXX ARCHITECT: XXXXXXXX

DATE: March, 21, 2014  
SCALE: XXXXXX  
DRAWN: P  
JOB: XXXXXXXX  
SHEET

**3.01**

THIS DRAWING IS NOT TO SCALE IF NOT PRINTED ON 24" X 36" PAPER  
 PRL GLASS SYSTEMS INC. 4180 S. 130TH AVENUE, SUITE 100, LITTLETON, CO 80120

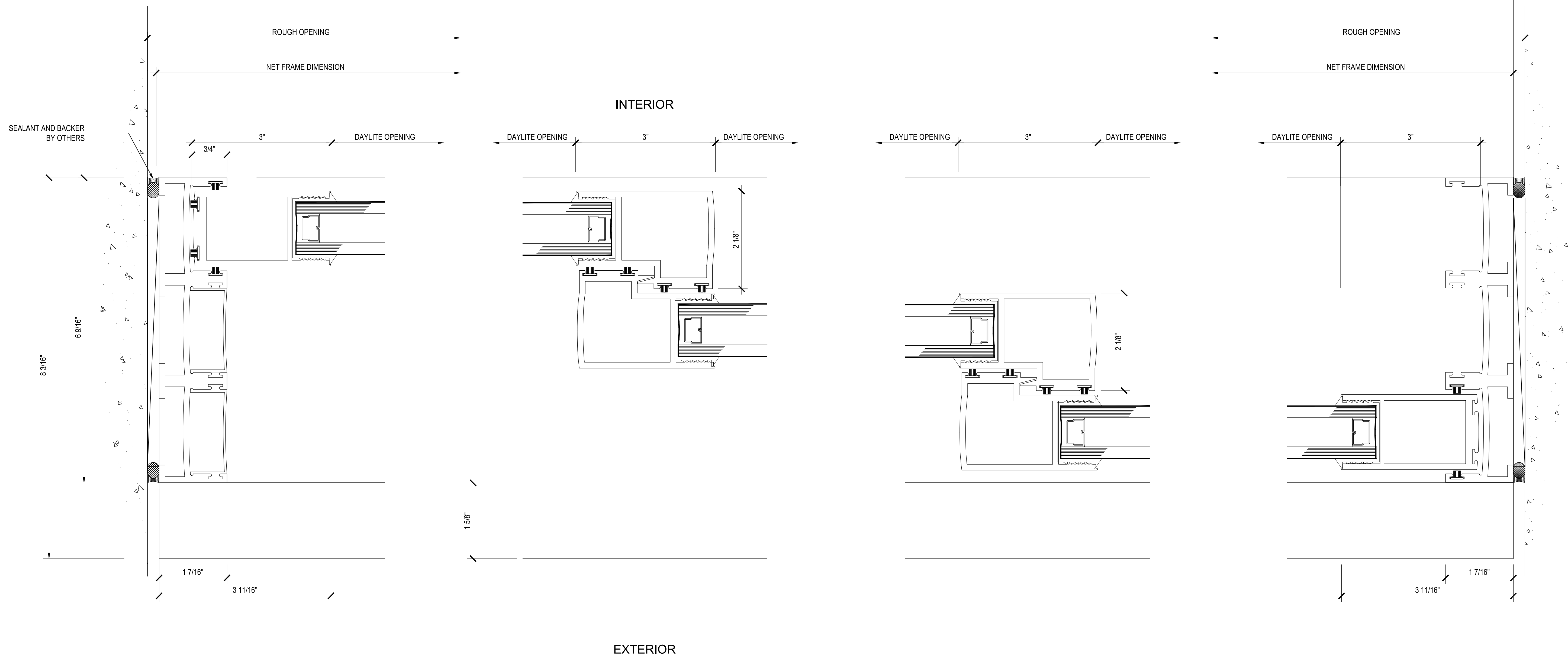

**A** Section @ Jambs  
Max-Slider Sliding Glass Door (XXO)

ARCHITECT OF RECORD'S APPROVAL

STRUCTURAL ENGINEER OF RECORD'S APPROVAL

STRUCTURAL ENGINEER'S APPROVAL

GENERAL CONTRACTOR'S APPROVAL

REVISIONS	BY
▲	
▲	
▲	
▲	
▲	

job name  
job name  
job name  
address

GENERAL CONTRACTOR: XXXXXXXX ARCHITECT: XXXXXXXX

DATE: March, 21, 2014  
SCALE: XXXXX  
DRAWN: P  
JOB: XXXXXXXX  
SHEET

**4.01**

ALL IDEAS, DESIGNS, ARRANGEMENTS AND PLANS INDICATED OR REPRESENTED BY THESE DRAWINGS ARE OWNED BY AND THE PROPERTY OF PRL GLASS SYSTEMS INC. NO PART THEREOF SHALL BE REPRODUCED, COPIED, ADAPTED, DISTRIBUTED TO OTHERS, PUBLISHED, SOLD OR OTHERWISE USED WITHOUT THE PRIOR WRITTEN CONSENT OF AND APPROPRIATE COMPENSATION TO PRL GLASS SYSTEMS INC. COPYRIGHT ©

THIS DRAWING IS NOT TO SCALE IF NOT PRINTED ON 24" X 36" PAPER



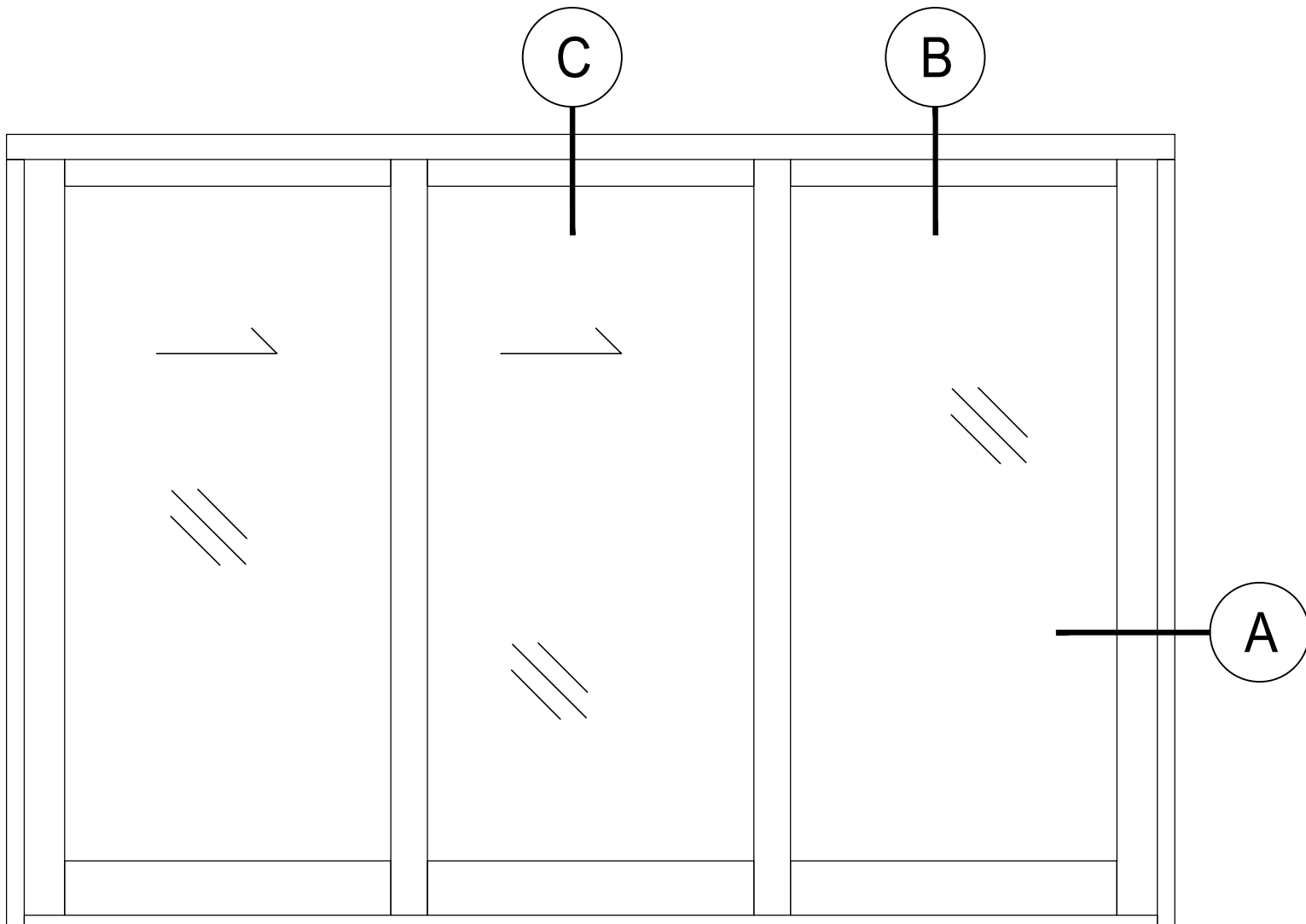

**PRL** GLASS SYSTEMS INC. 

Telephone : (877) 775-25856      251 Mason Way  
 Fax No. : (626) 968-95256      City of Industry, C.A.  
 www.prl.glass.com      www.prlaluminum.com

**Max Slider: Sliding Glass Door - Medium Stile - MS / MS / MS**  
**Sliding Door / Fixed Panel ( XXO )**

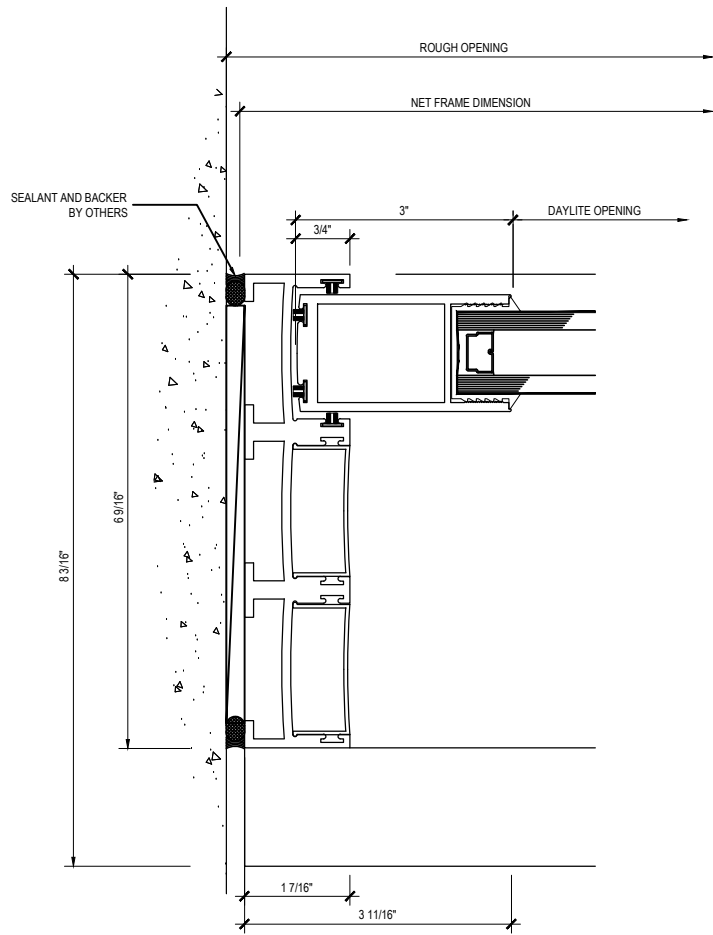

INTERIOR

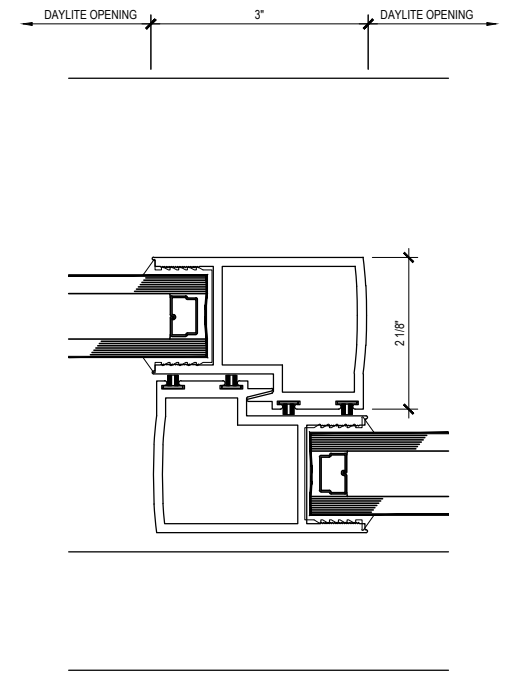
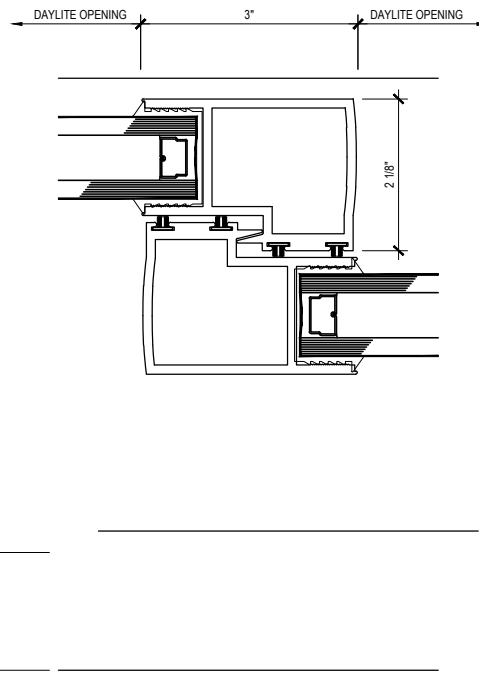

EXTERIOR

A

Section @ Jamb

Max-Slider Sliding Glass Door (XXO)

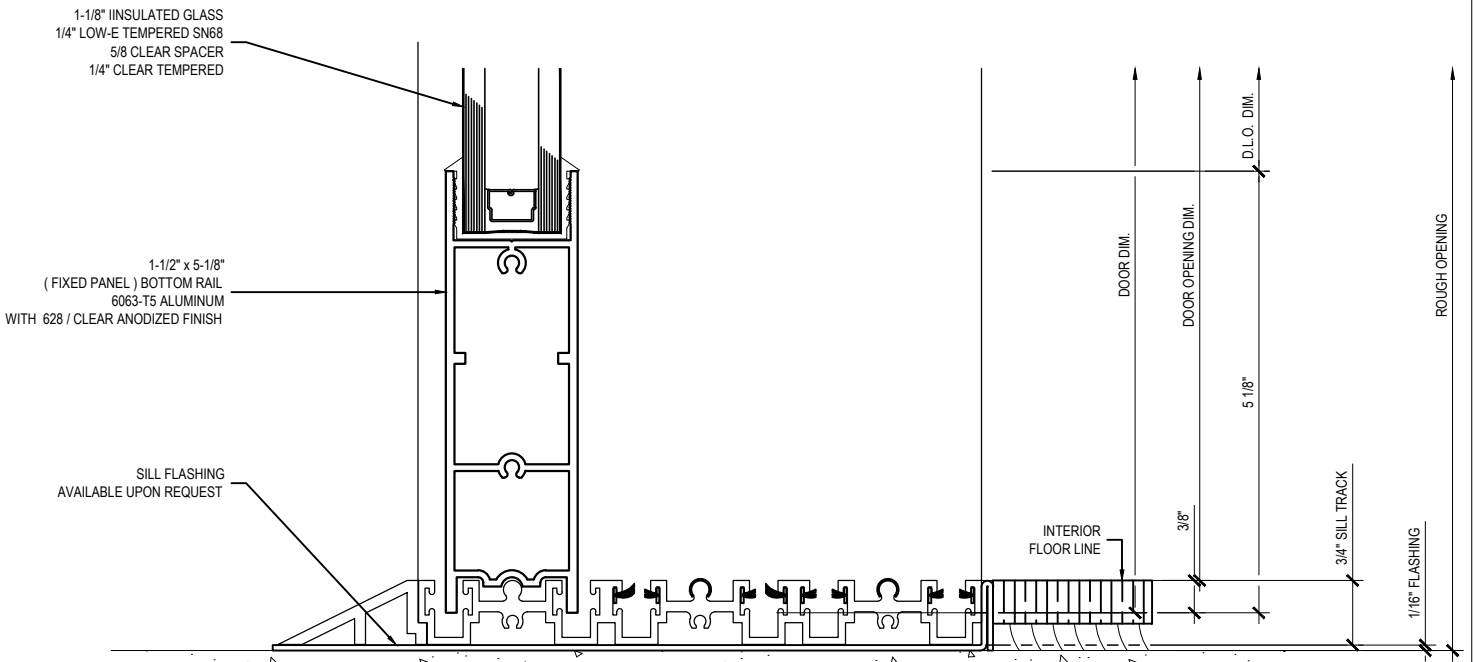
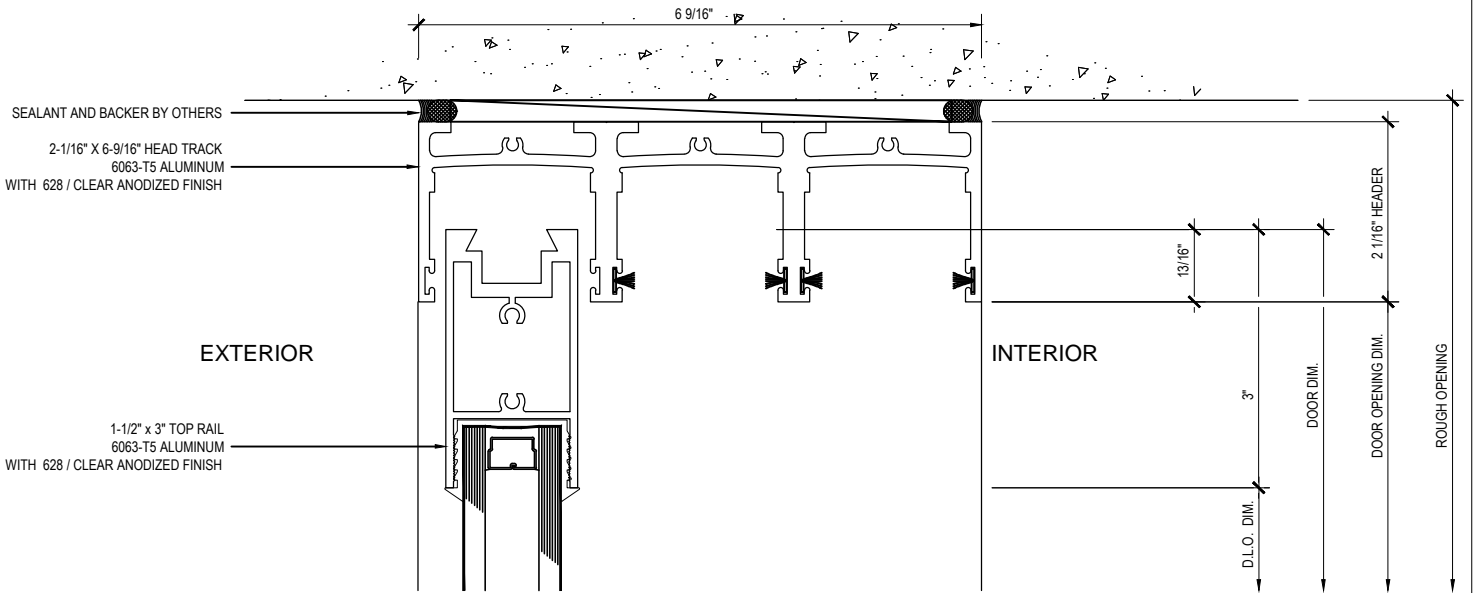

**B**

Section @ (Fixed)

Max-Slider Sliding Glass Door (XXO)



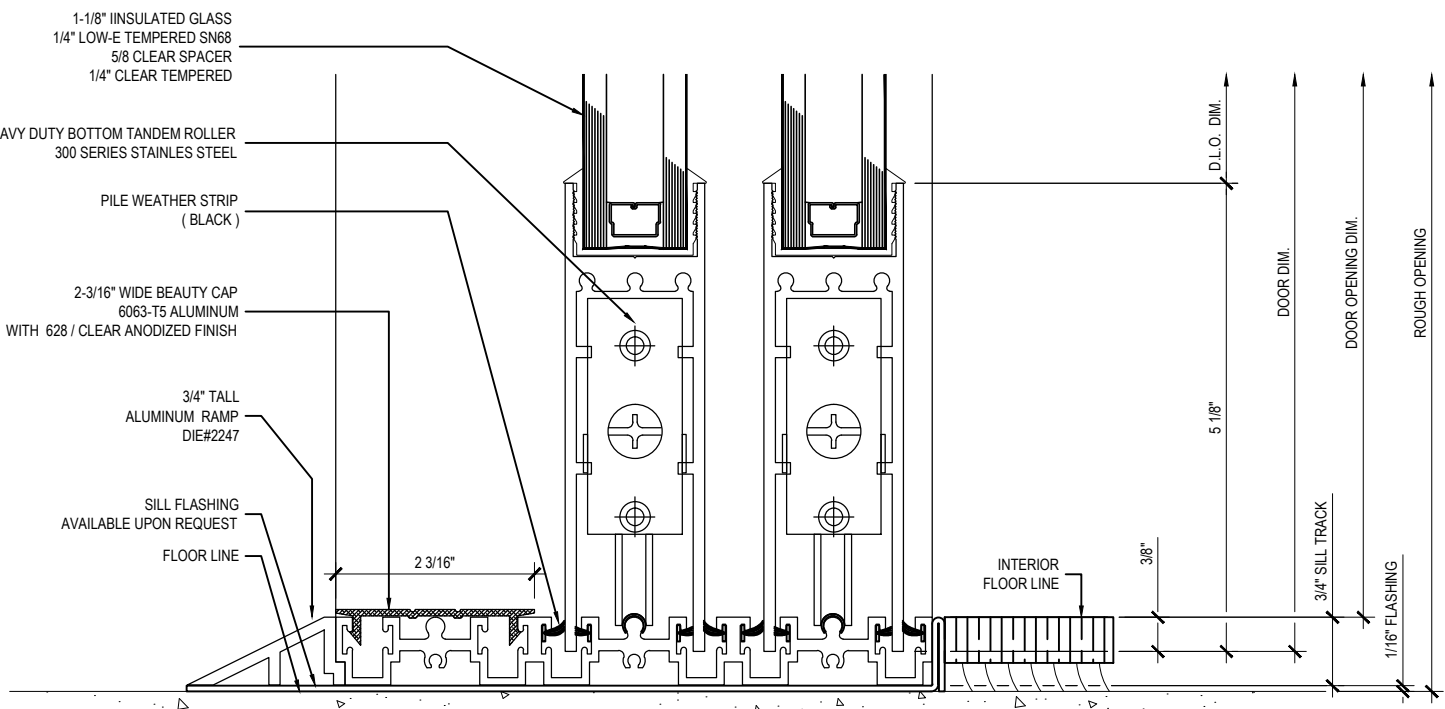
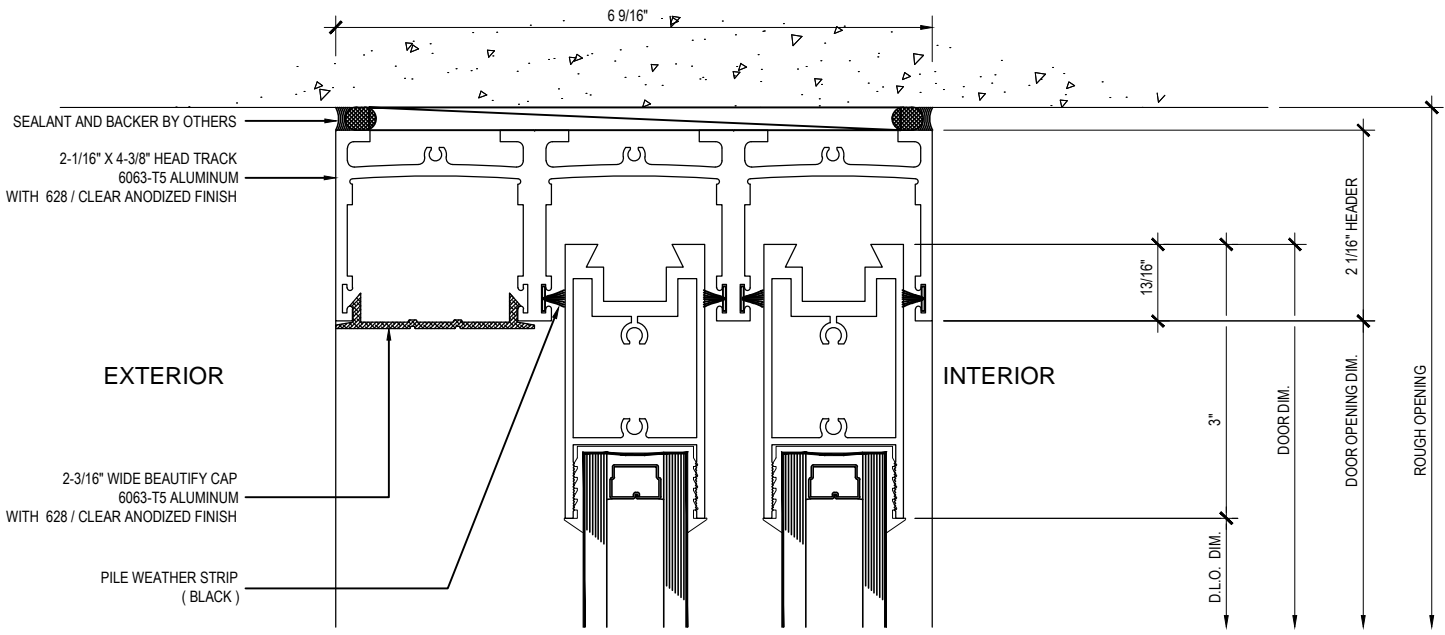

**C**

**Section @ (Slider)**

**Max-Slider Sliding Glass Door (XXO)**