

TIFFANY SERIES

SLIDING GLASS SYSTEM

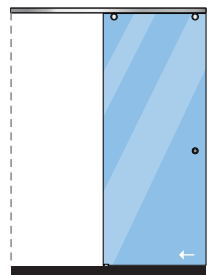

CONFIGURATIONS



X-SINGLE DOOR

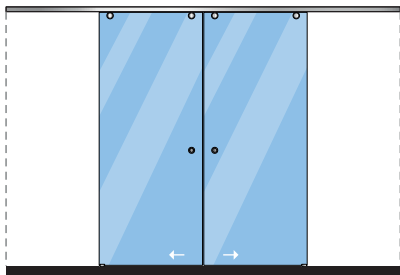

XX-DOUBLE DOOR

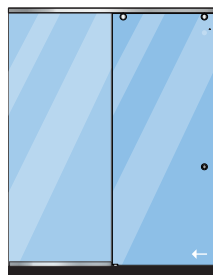

OX-SINGLE DOOR & SIDELITES

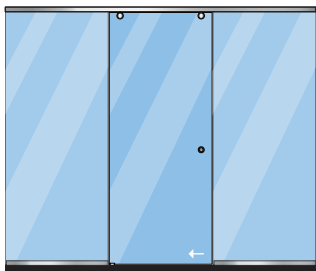

OXO-SINGLE DOOR & TWO SIDELITES

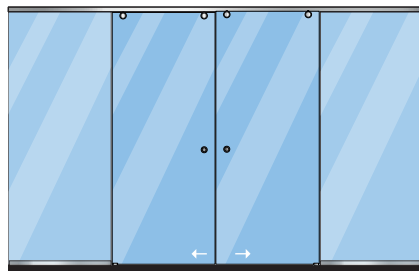

OXXO-DOUBLE DOOR & TWO SIDELITES

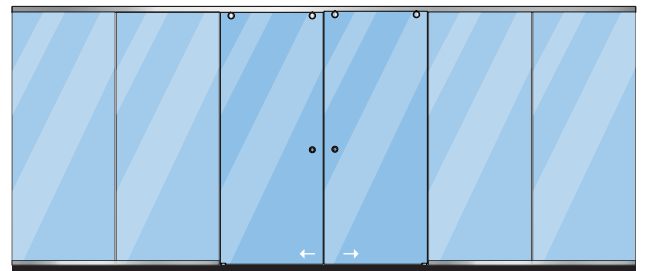

OOOO-DOUBLE DOOR & TWO SIDELITES ON EACH SIDE



2 Rollers - 200 lbs
3 Rollers - 275 lbs



Wall Mount & Fascia Mount



Glass Color: Clear, Tinted, Starphire, Texture & Laminated Glass



Patch Lock, Center Lock or Locking Ladder Pull



Standard C Pull, Ladder Pull, Finger Pull, Offset Pull or Locking Ladder Pull

TIFFANY SERIES

SLIDING GLASS SYSTEM

1 TIFFANY TOP TRACKS

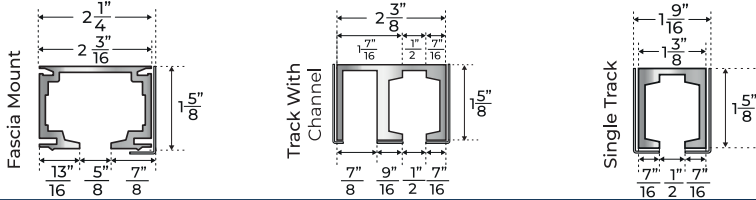

2 TIFFANY ROLLER

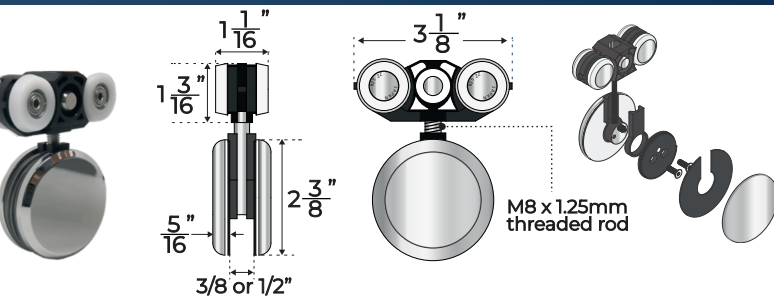

3 TIFFANY PULLS

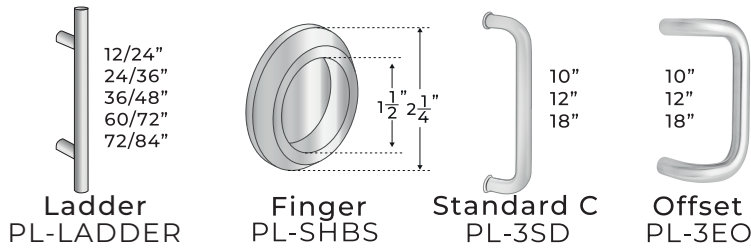

4 GLASS THICKNESS | COLORS



5 TIFFANY FLOOR DOOR GUIDE

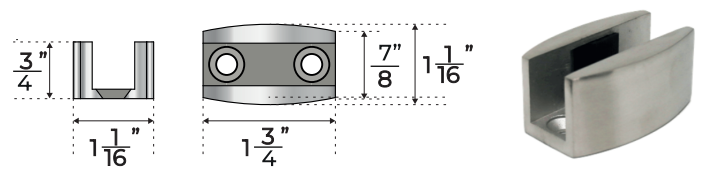

AVAILABLE FINISHES



POLISHED S.S. FINISH



BRUSHED S.S. FINISH



CUSTOM PAINTED

Single Track Only

SHPST

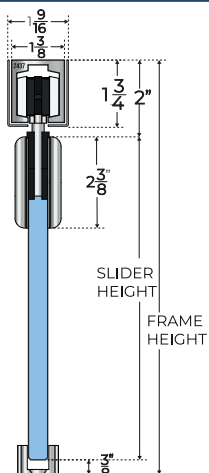

Track With Channel

SHPDT

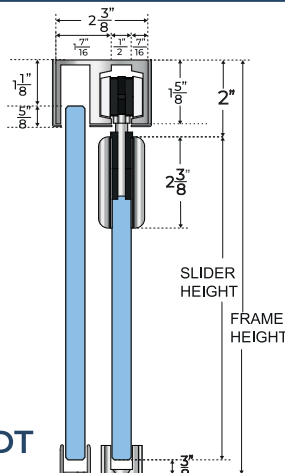

Fascia Mount

PLTTFT

