

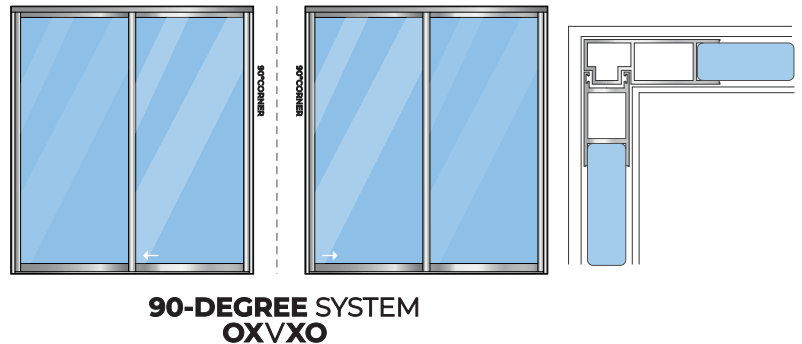

MAX SLIDER ALUMINUM SLIDERS

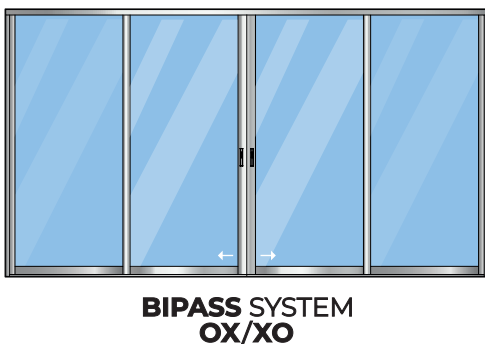

CONFIGURATIONS

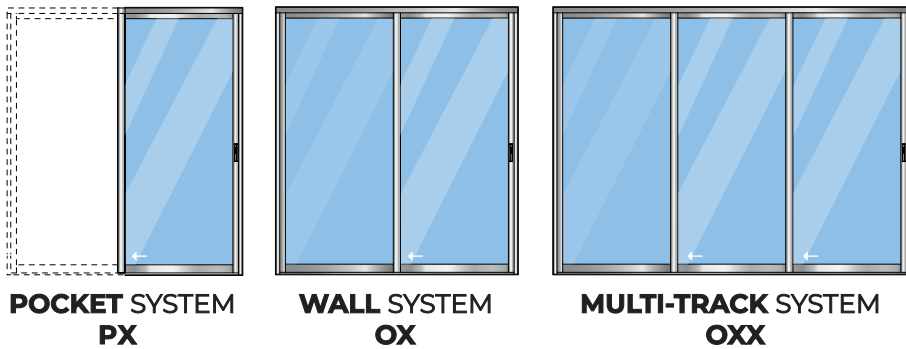

-  **Cabo Series**
Top Hung
150 lbs each Roller
-  **Cancun Series**
Bottom Roller
Std 1.75" Roller - 600 lbs
Quad Roller - 1,300 lbs

-  **Top Hung Roller - CABO**
-  **Bottom Roller - CUNCUN**

-  **Glass Color: Clear, Tinted, Starphire, Texture, Laminated Glass & Insulated Glass 1-1/8"**

-  **Max Panel Width: 72"**
Max Panel Height: 120"
**Custom oversize available subject to prior consultation*

-  **Screen Options:**
Retractable screen
Nail fin screen
Regular Door Screen

MAX SLIDER ALUMINUM SLIDERS

1 MAX PROFILES

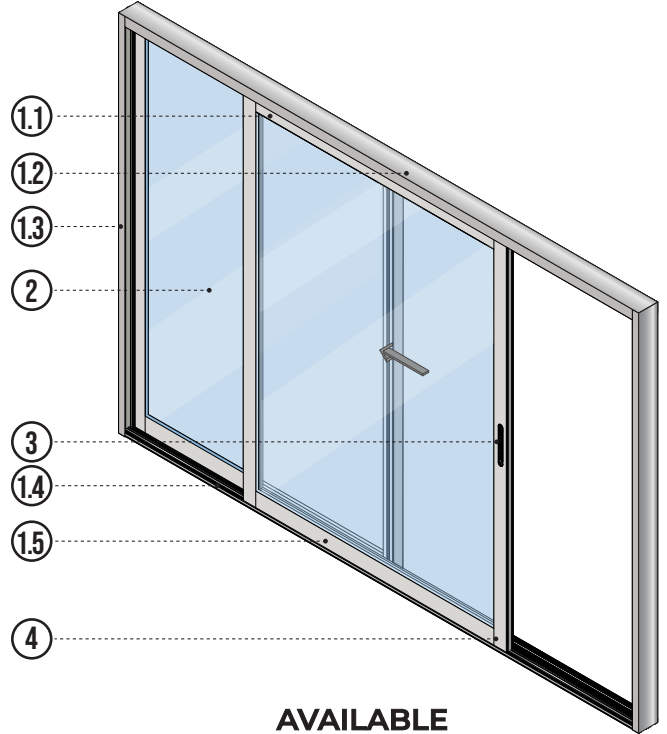
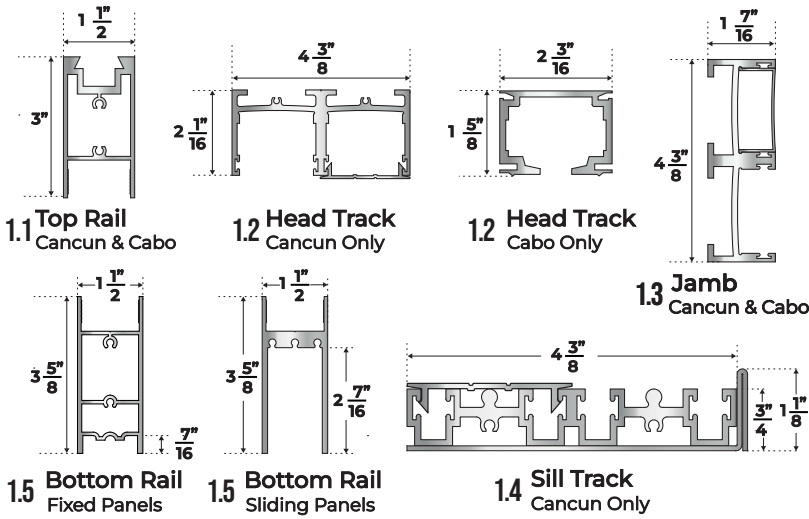

2 GLASS THICKNESS | COLORS

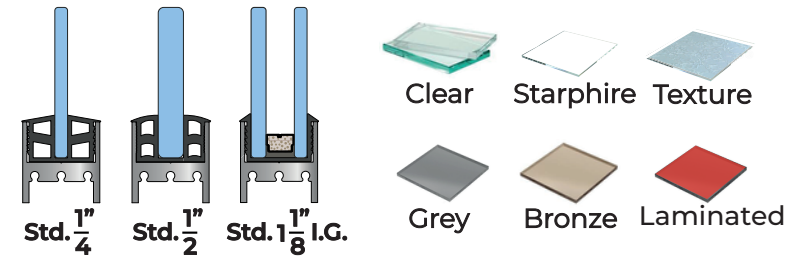

AVAILABLE FINISHES



3 MAX LOCKS

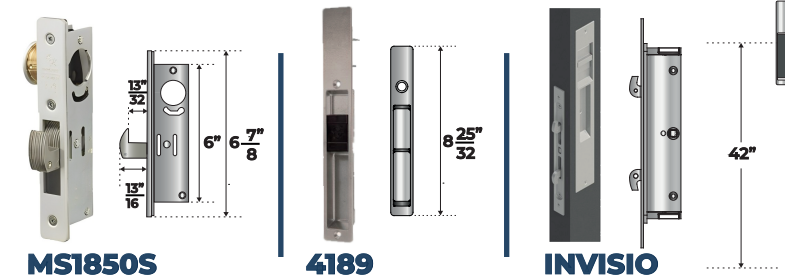

4 ROLLER OPTIONS

