

BI - FOLD HIGH SILL

DOOR SYSTEM IN A SINGLE DIRECTION (LEFT)
3L PANELS - STACKING OUT
X - DOORS

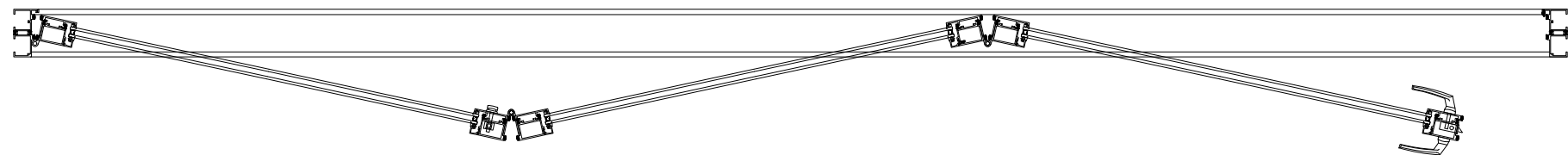
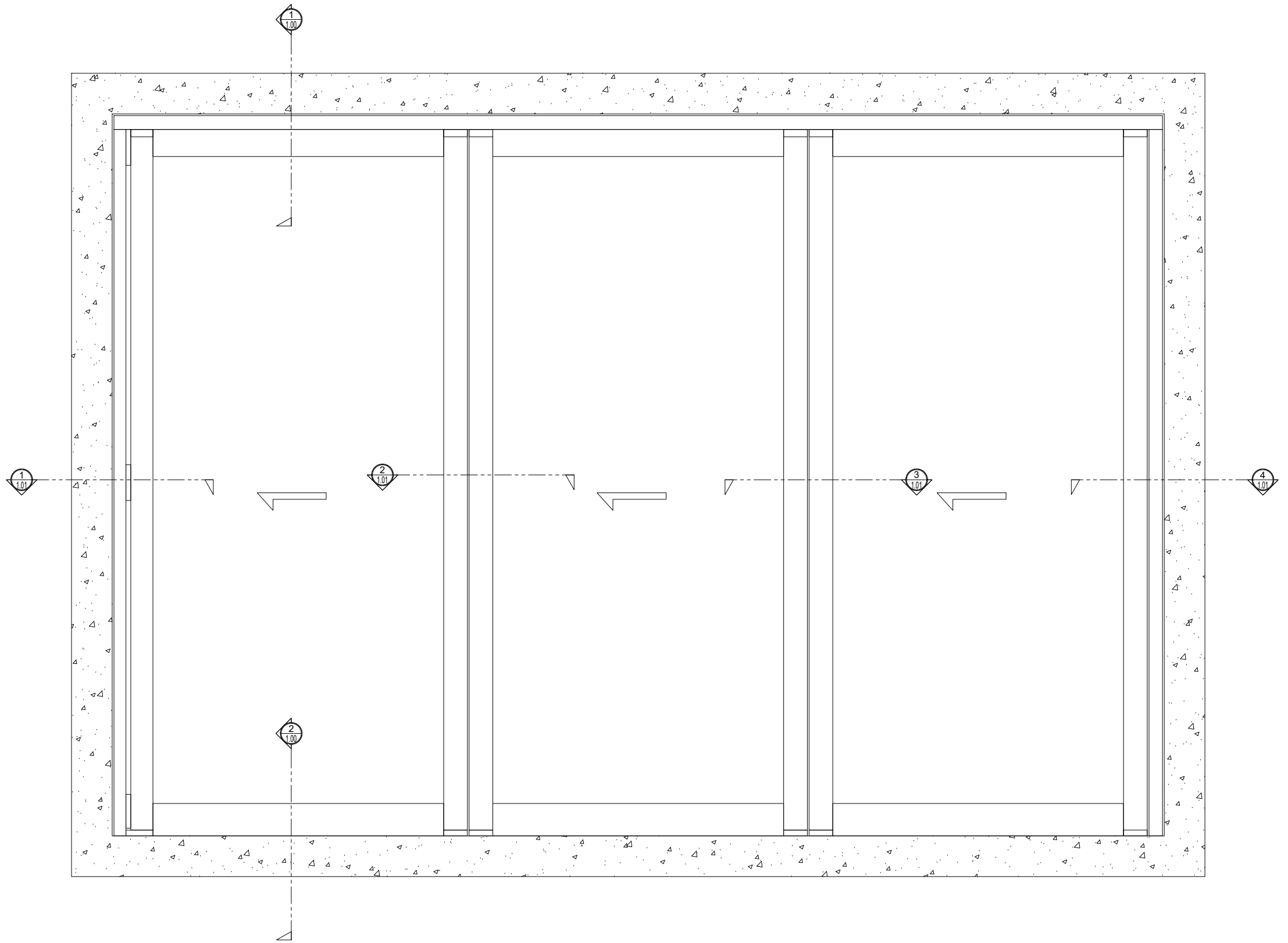
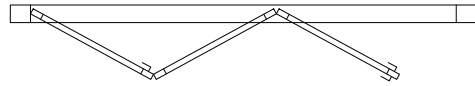

BI - FOLD HIGH SILL

DOOR SYSTEM IN A SINGLE DIRECTION (LEFT)
 3L PANELS - STACKING OUT
 X - DOORS

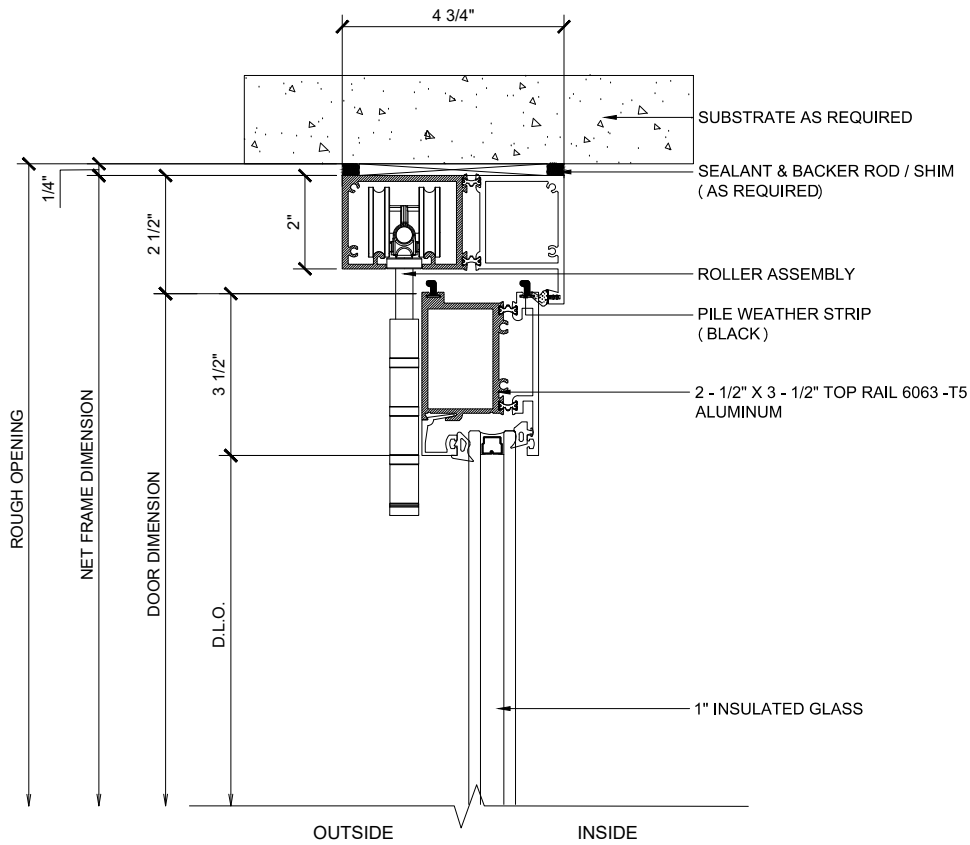

① HEAD (@DOOR)

BI-FOLD DOOR SYSTEM (XXX) SCALE: 6"=1'-0"

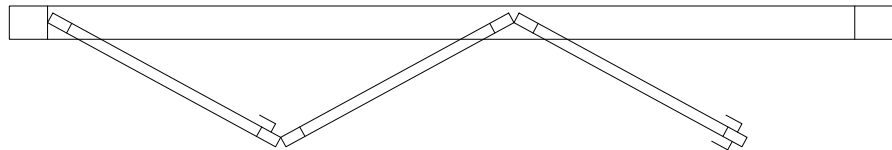

Ⓐ CONFIGURATION

BI-FOLD DOOR SYSTEM (XXX) SCALE: 6"=1'-0"

- Finishes:
- Clear and Bronze anodized finishes Class 1
 - Standard Mill Finish available for custom colors
 - Kynar

Custom finishes available

NOTE: When using maximum panel width & height 42" x 120" panel may exceed maximum panel weight of 220 lbs, consult PRL for details.

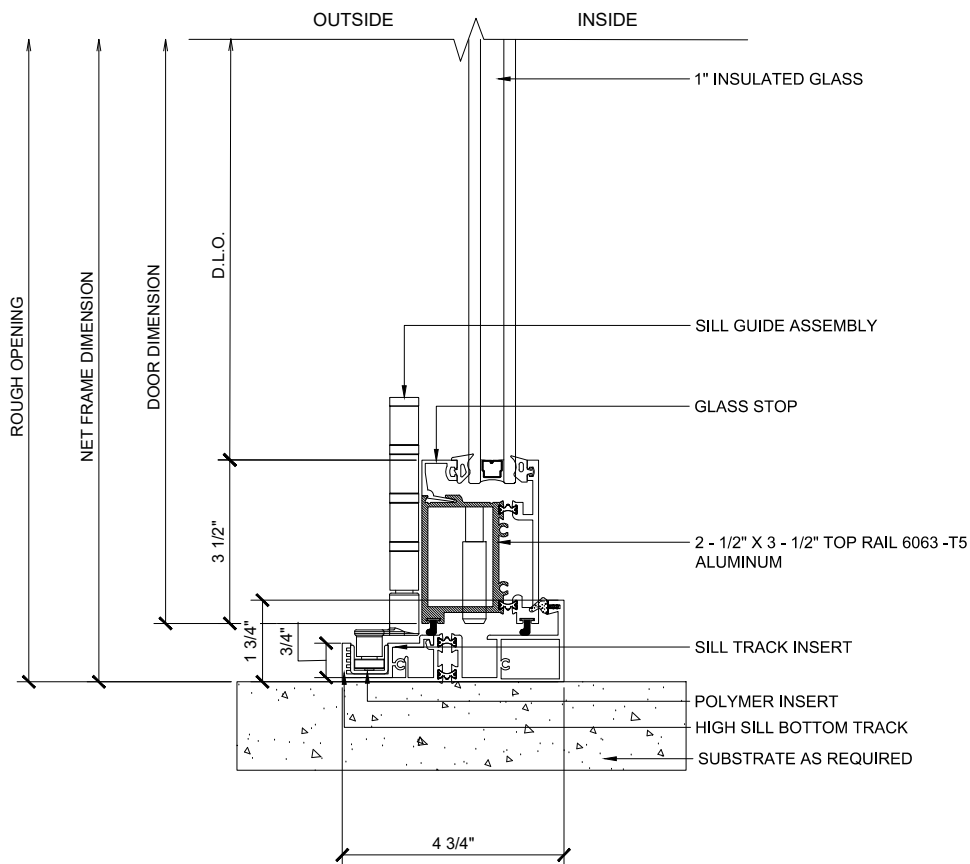

② HIGH SILL (@DOOR)

BI-FOLD DOOR SYSTEM (XXX) SCALE: 6"=1'-0"

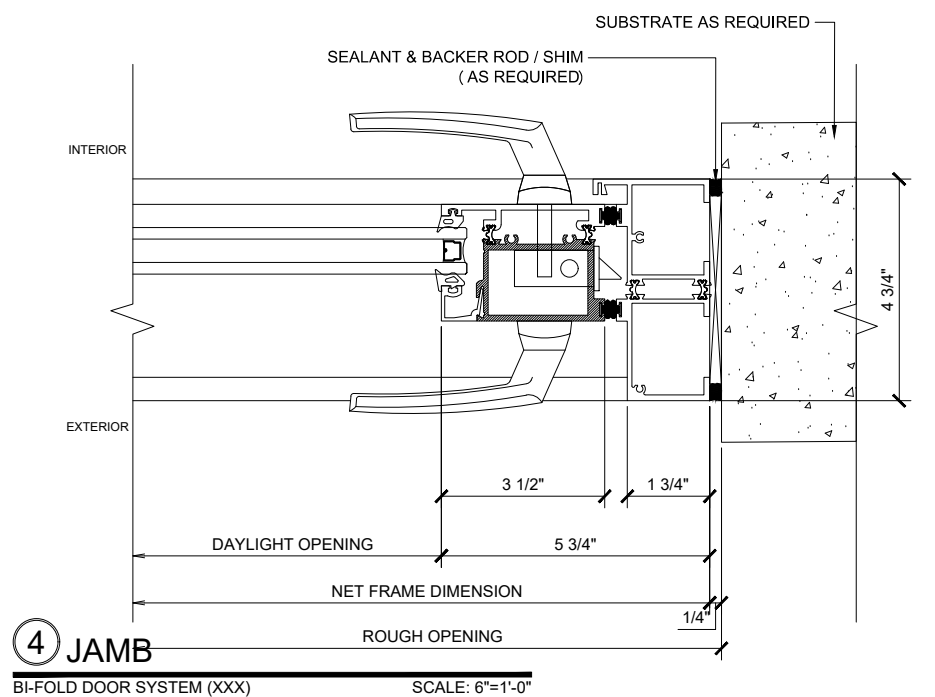
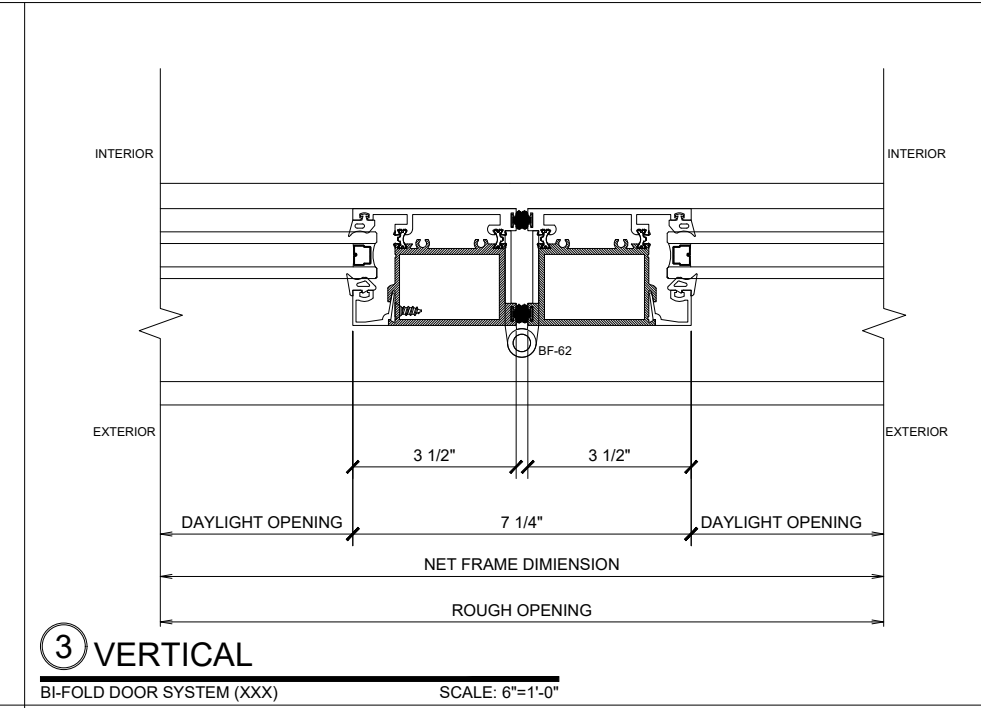
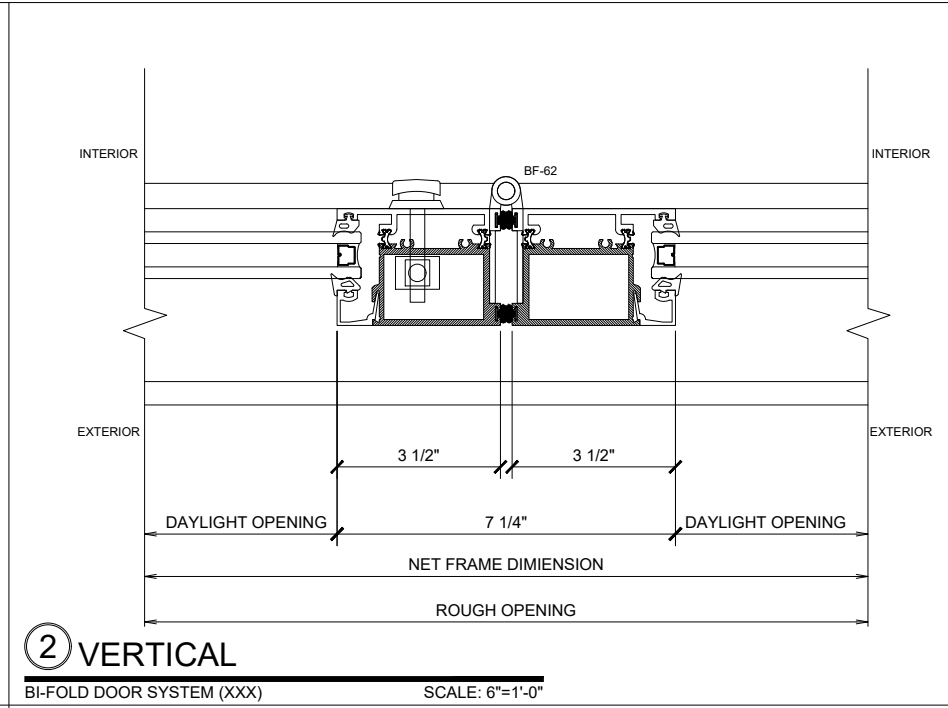
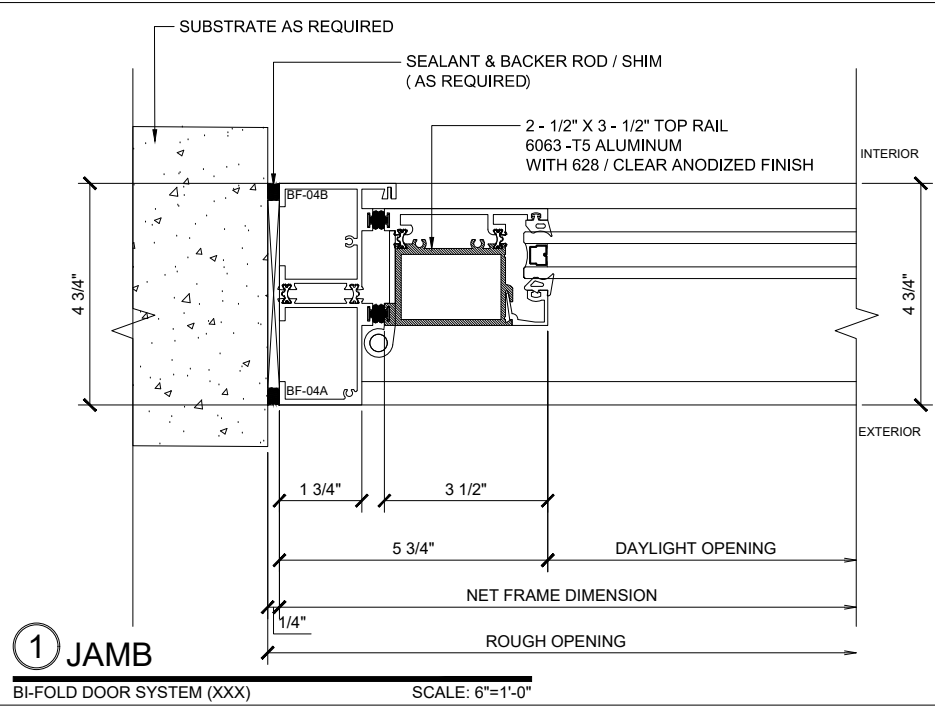



ADDRESS: 13644 NELSON AVE. CITY OF INDUSTRY, CA.
TEL: (877) 775-25856
FAX No.: (626) 968-95256
WEBSITE: www.prl-glass.com www.prlaluminum.com

BI - FOLD

NO SILL

DOOR SYSTEM IN A SINGLE DIRECTION (LEFT)
3L PANELS - STACKING OUT
X - DOORS

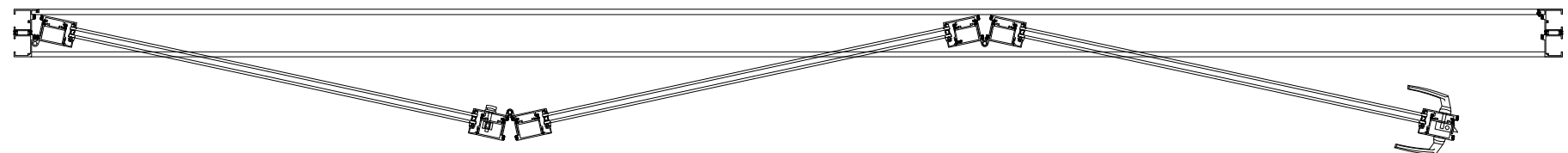
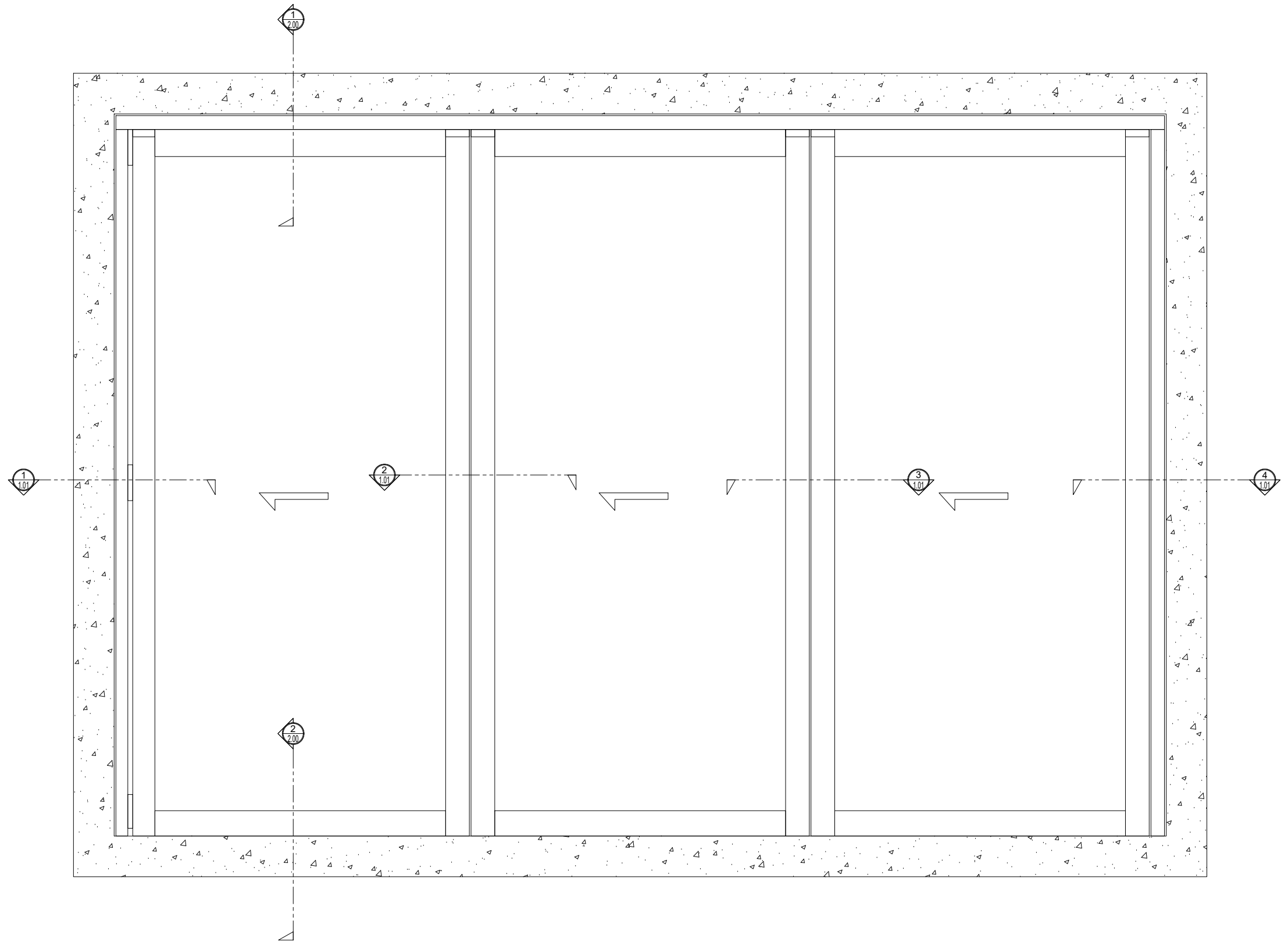
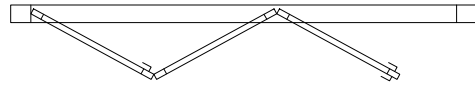

BI - FOLD NO SILL

DOOR SYSTEM IN A SINGLE DIRECTION (LEFT)
 3L PANELS - STACKING OUT
 X - DOORS

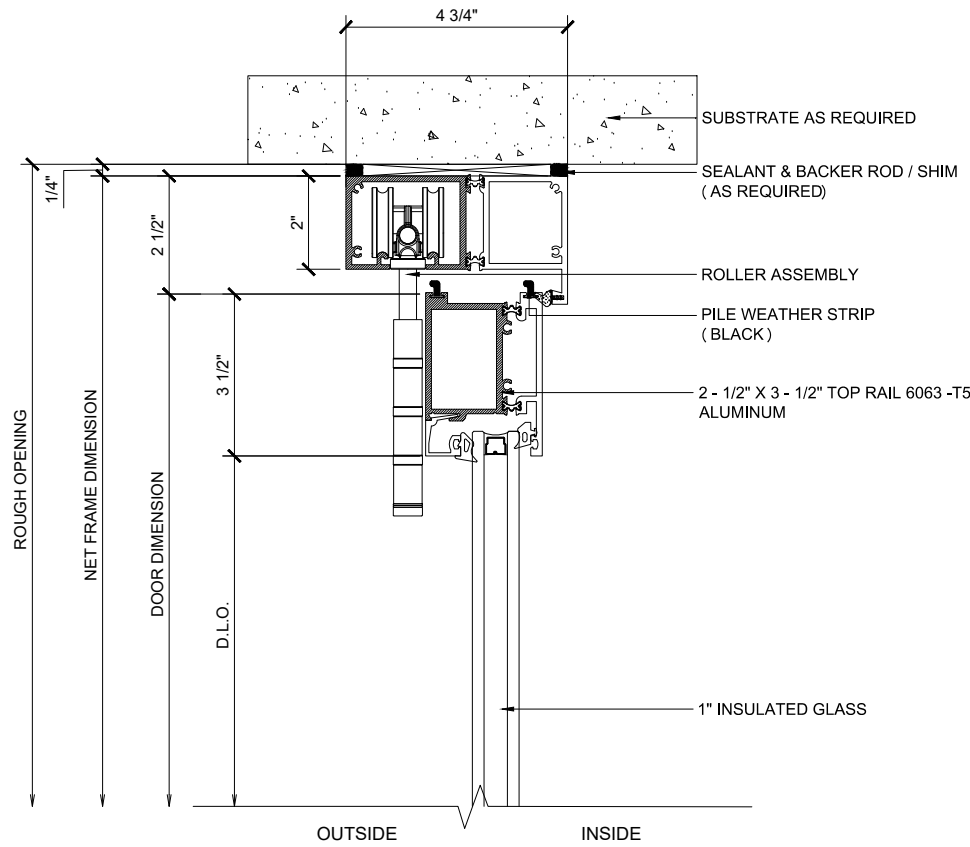

① HEAD (@DOOR)

BI-FOLD DOOR SYSTEM (XXX) SCALE: 6"=1'-0"

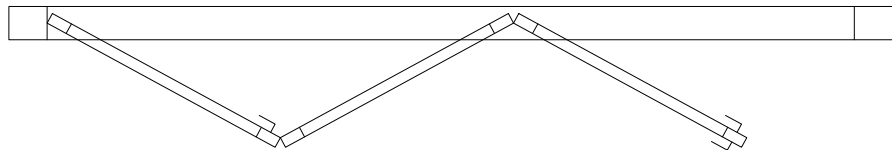

Ⓐ CONFIGURATION

BI-FOLD DOOR SYSTEM (XXX) SCALE: 6"=1'-0"

Finishes:

- Clear and Bronze anodized finishes Class 1
- Standard Mill Finish available for custom colors
- Kynar

Custom finishes available

NOTE: When using maximum panel width & height 42" x 120" panel may exceed maximum panel weight of 220 lbs, consult PRL for details.

NO WATERPROOF

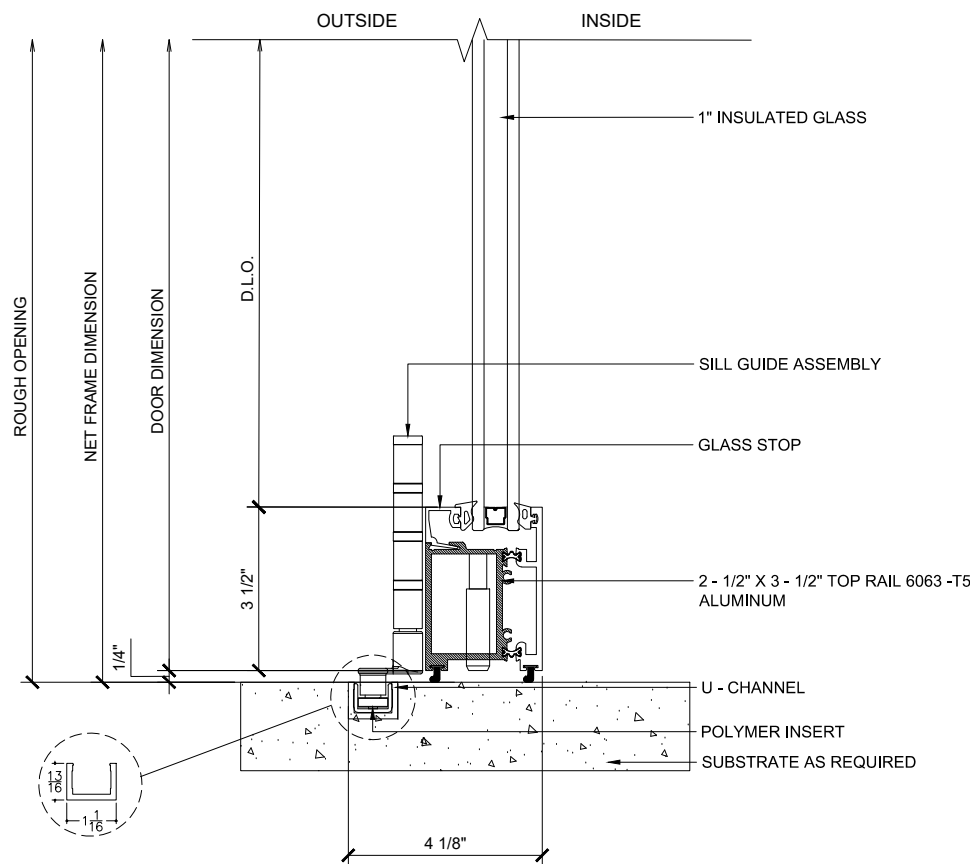

② NO SILL (@DOOR)

BI-FOLD DOOR SYSTEM (XXX) SCALE: 6"=1'-0"



ADDRESS: 13644 NELSON AVE. CITY OF INDUSTRY, CA.
TEL: (877) 775-25856
FAX No.: (626) 968-95256
WEBSITE: www.prl-glass.com www.prlaluminum.com

BI - FOLD

LOW SILL

DOOR SYSTEM IN A SINGLE DIRECTION (LEFT)
3L PANELS - STACKING OUT
X - DOORS

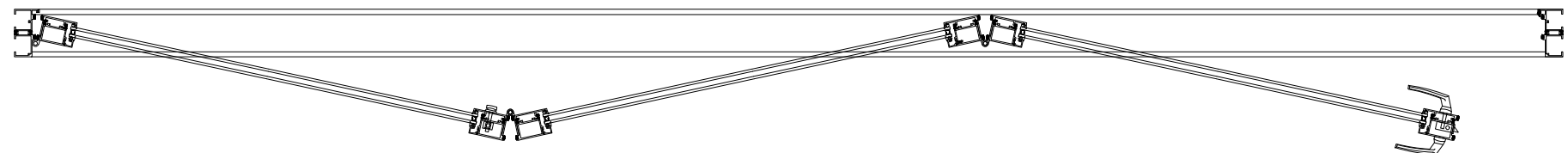
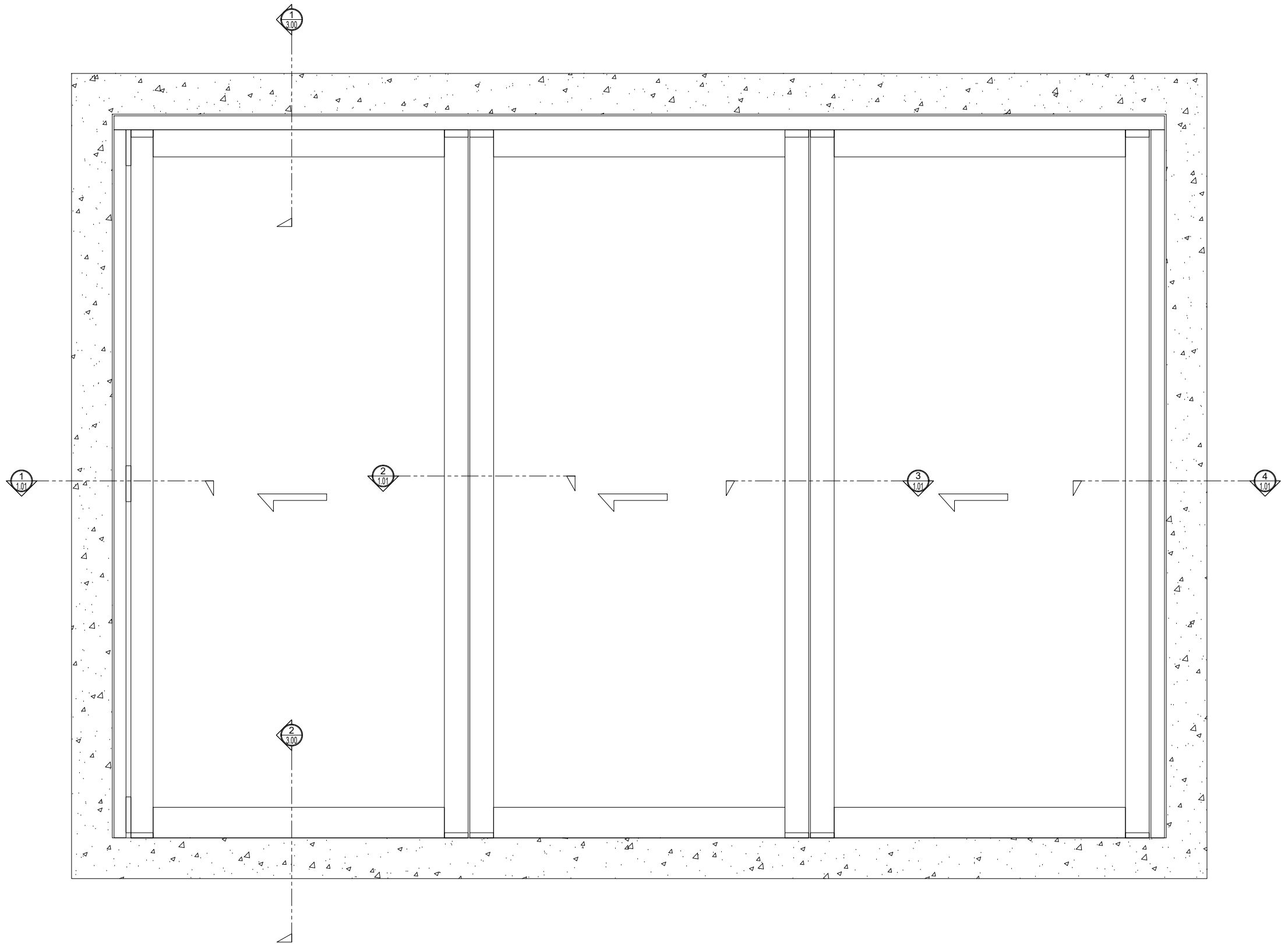
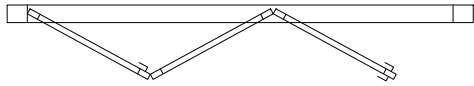

BI - FOLD LOW SILL

DOOR SYSTEM IN A SINGLE DIRECTION (LEFT)
 3L PANELS - STACKING OUT
 X - DOORS

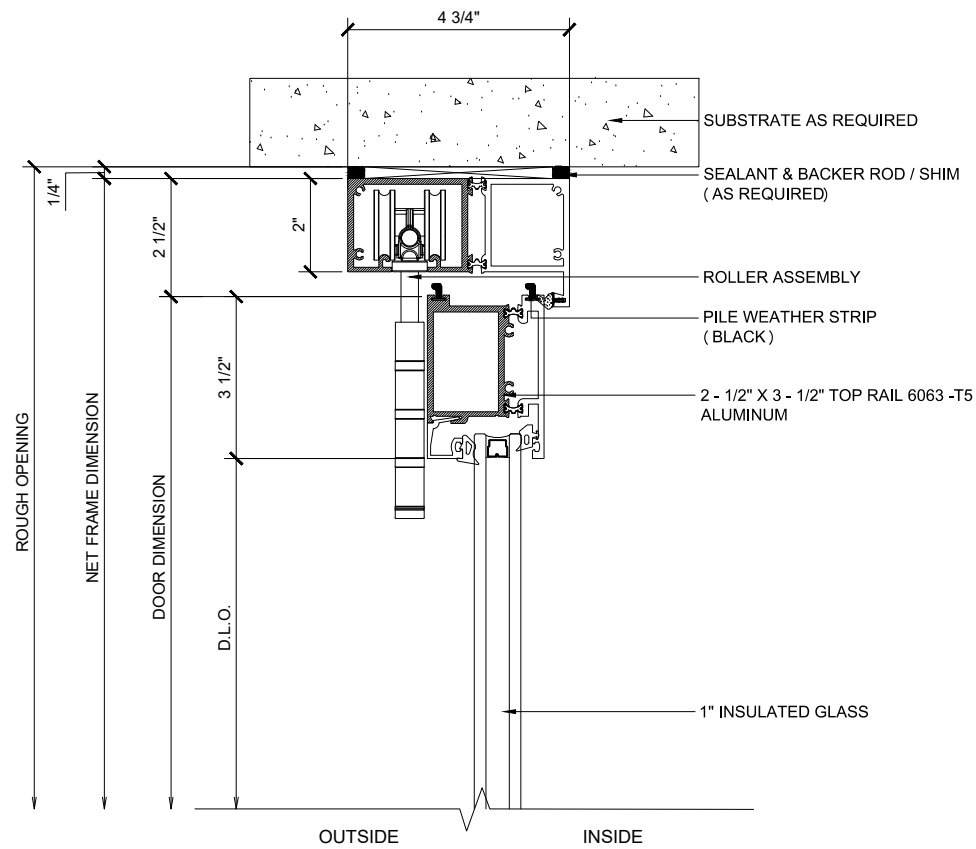

① HEAD (@DOOR)

BI-FOLD DOOR SYSTEM (XXX) SCALE: 6"=1'-0"

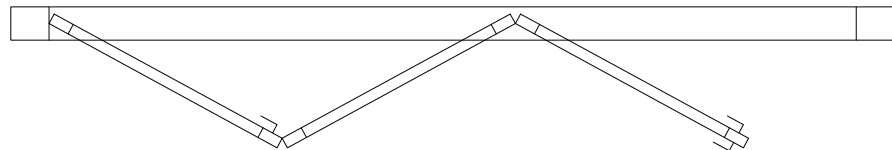

Ⓐ CONFIGURATION

BI-FOLD DOOR SYSTEM (XXX) SCALE: 6"=1'-0"

Finishes:

- Clear and Bronze anodized finishes Class 1
- Standard Mill Finish available for custom colors
- Kynar

Custom finishes available

NOTE: When using maximum panel width & height 42" x 120" panel may exceed maximum panel weight of 220 lbs, consult PRL for details.

NO WATERPROOF

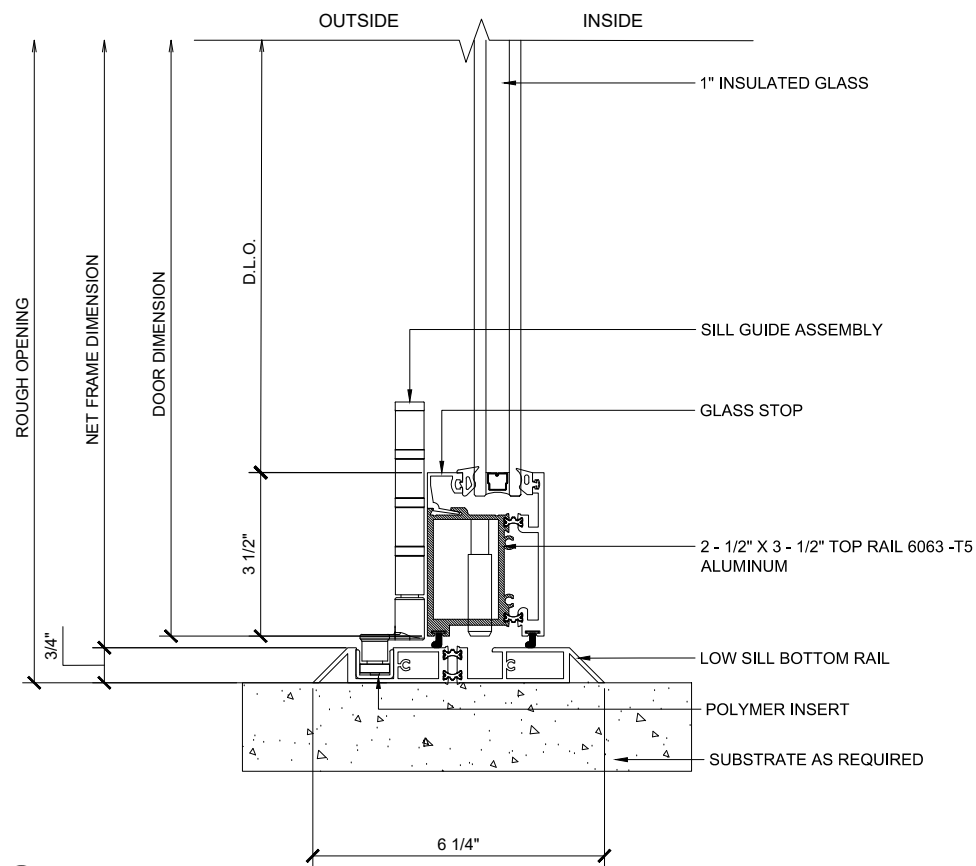

② LOW SILL (@DOOR)

BI-FOLD DOOR SYSTEM (XXX) SCALE: 6"=1'-0"

BI - FOLD

ADA SILL

DOOR SYSTEM IN A SINGLE DIRECTION (LEFT)
 3L PANELS - STACKING OUT
 X - DOORS

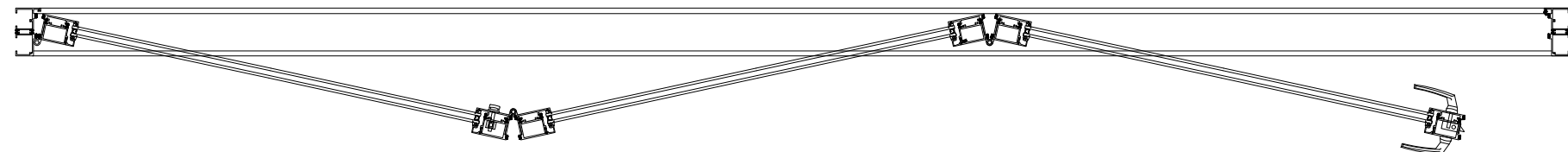
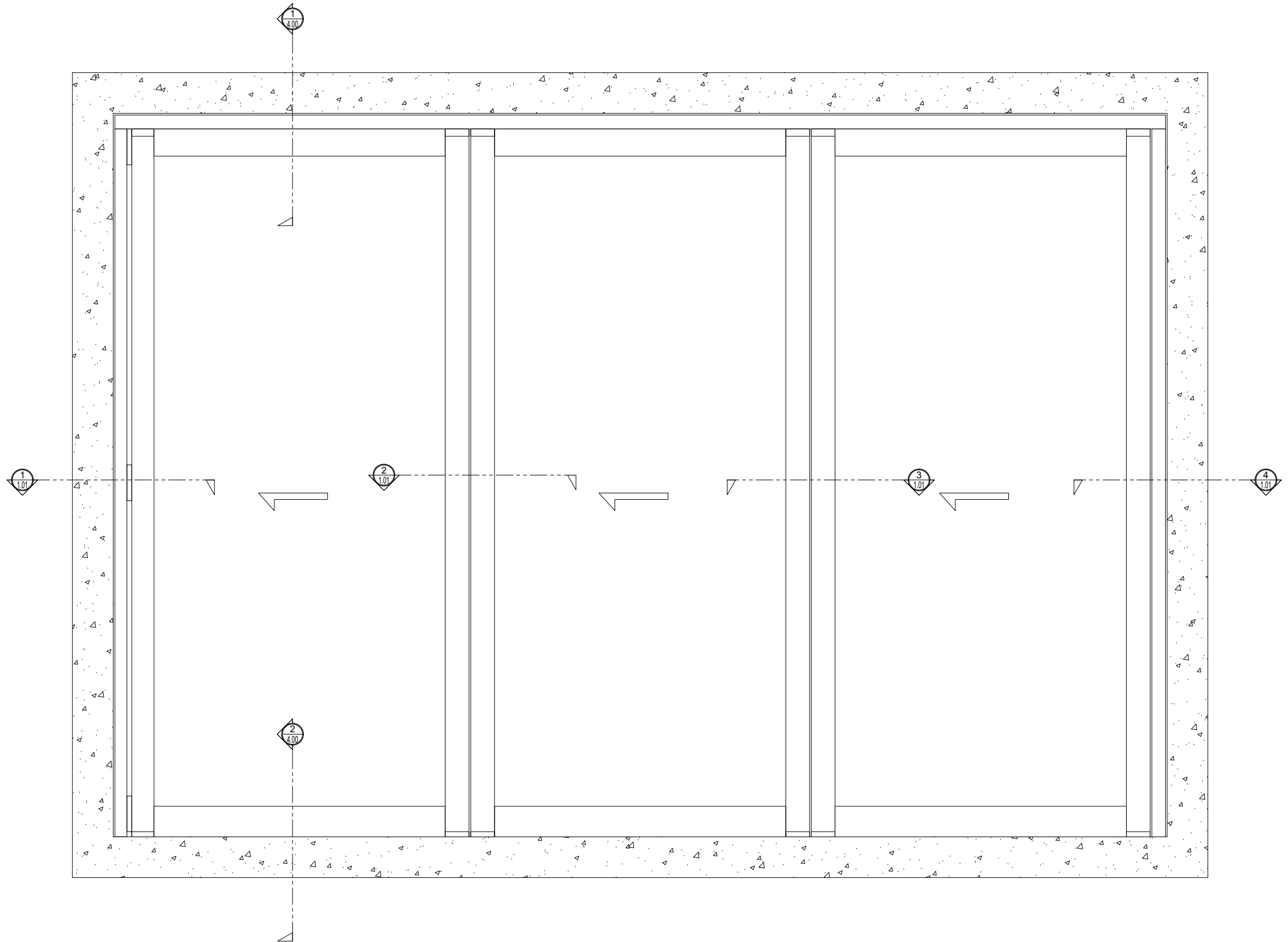
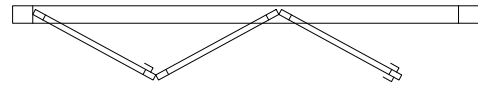

BI - FOLD

ADA SILL

DOOR SYSTEM IN A SINGLE DIRECTION (LEFT)
 3L PANELS - STACKING OUT
 X - DOORS

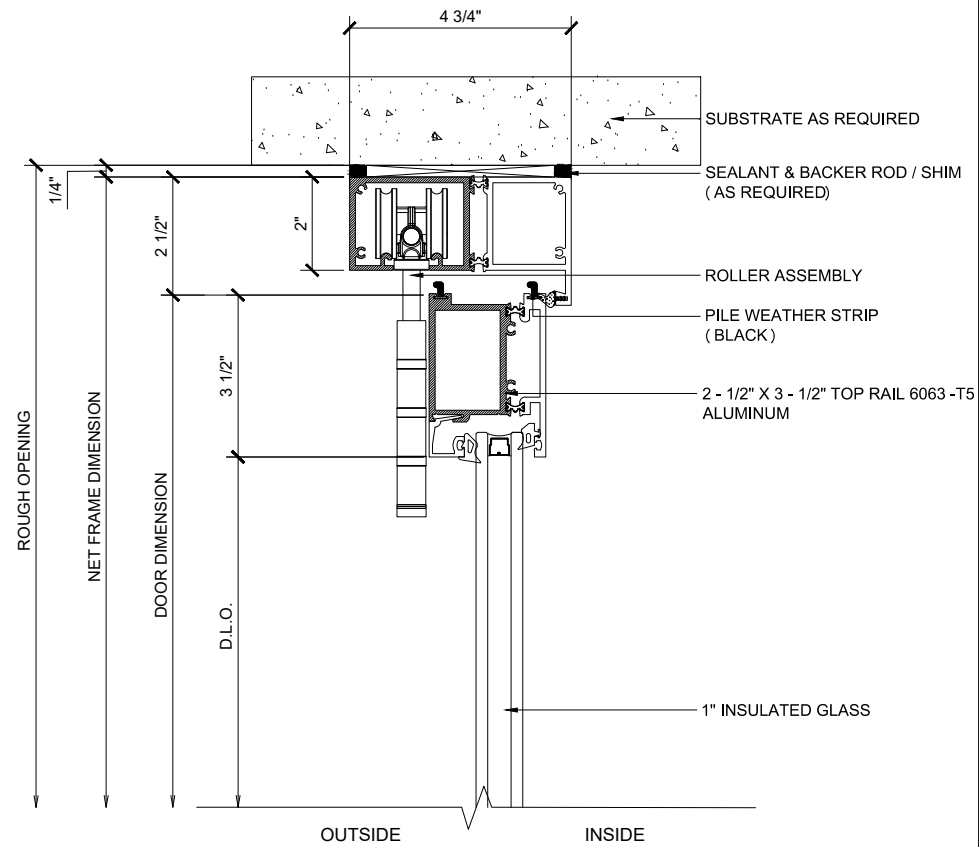

① HEAD (@DOOR)

BI-FOLD DOOR SYSTEM (XXX) SCALE: 6"=1'-0"

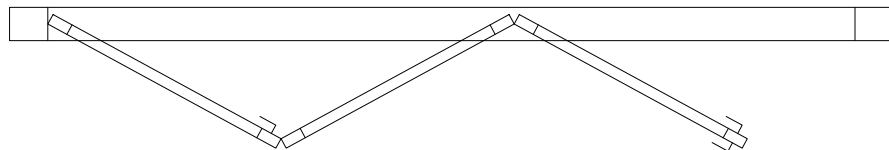

Ⓐ CONFIGURATION

BI-FOLD DOOR SYSTEM (XXX) SCALE: 6"=1'-0"

Finishes:

- Clear and Bronze anodized finishes Class 1
- Standard Mill Finish available for custom colors
- Kynar

Custom finishes available

NOTE: When using maximum panel width & height 42" x 120" panel may exceed maximum panel weight of 220 lbs, consult PRL for details.

NO WATERPROOF

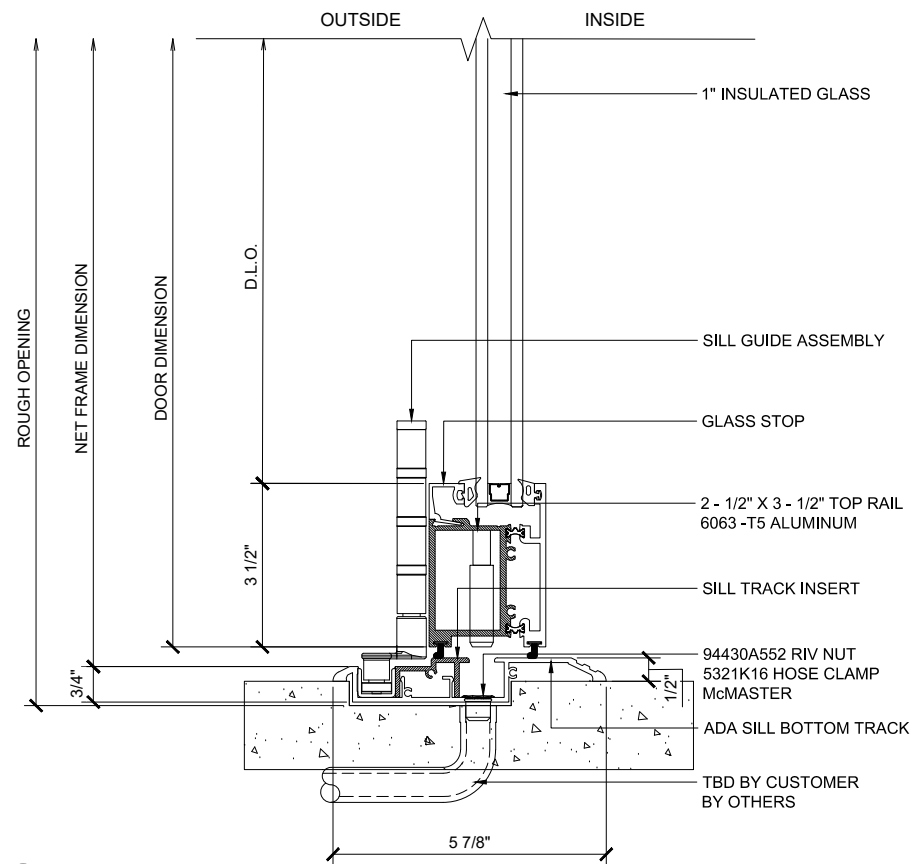

② ADA SILL (@DOOR)

BI-FOLD DOOR SYSTEM (XXX) SCALE: 6"=1'-0"