

ADDRESS: 13644 NELSON AVE. CITY OF INDUSTRY, CA.
TEL: (877) 775-2586
FAX No.: (626) 968-95256
WEBSITE: www.prlglass.com www.prlaluminum.com

BI - FOLD HIGH SILL

DOOR SYSTEM IN A BI-DIRECTION (LEFT - RIGHT)
1L-2R PANELS - STACKING OUT
X - DOORS

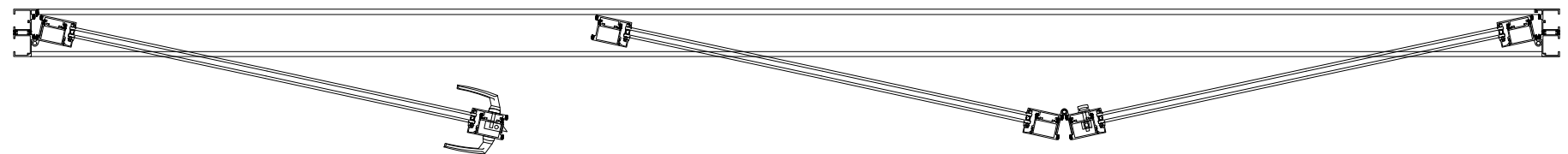
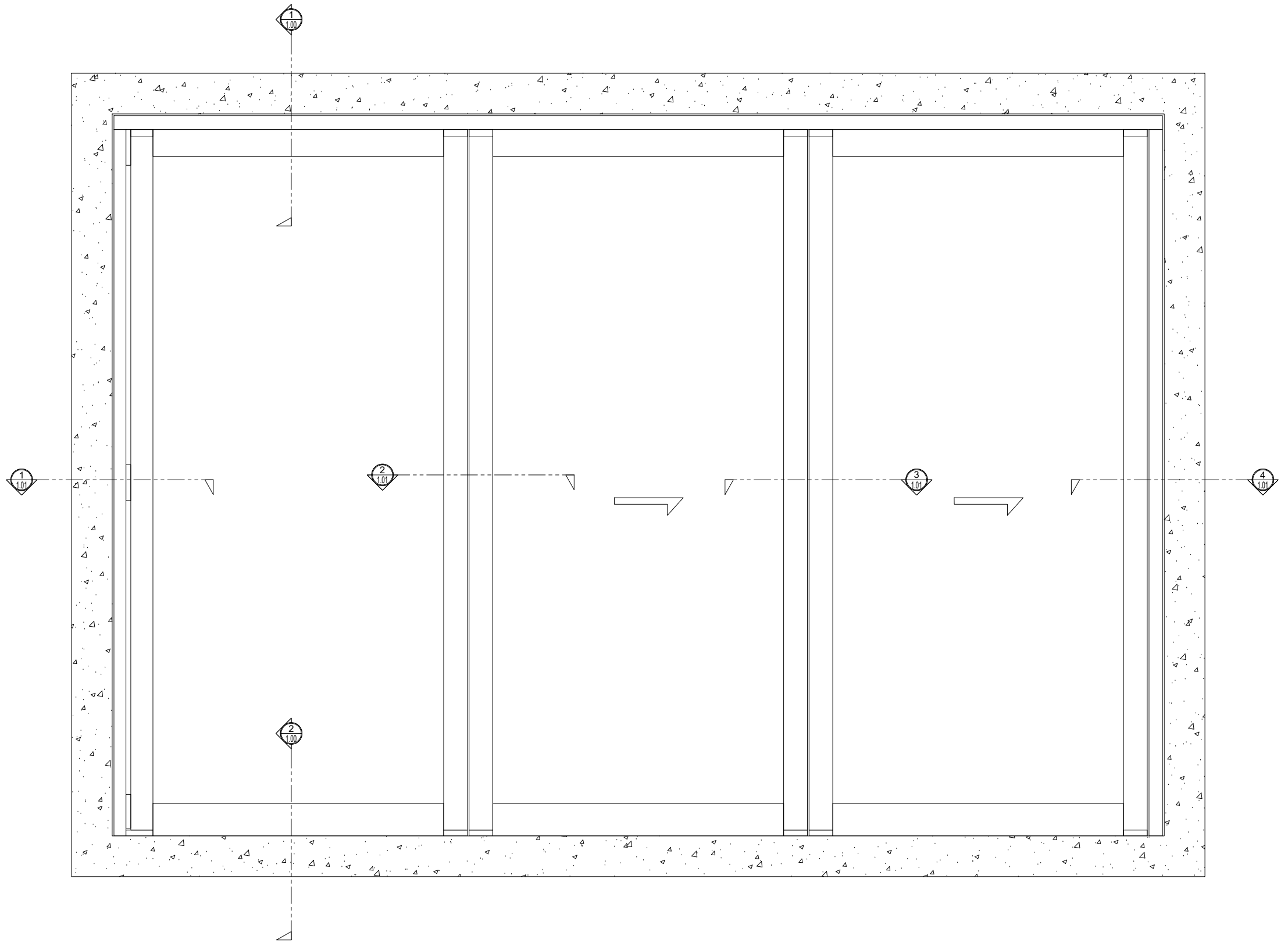
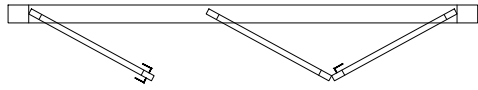

BI - FOLD HIGH SILL

DOOR SYSTEM IN A BI-DIRECTION (LEFT - RIGHT)
 1L-2R PANELS - STACKING OUT
 X - DOORS

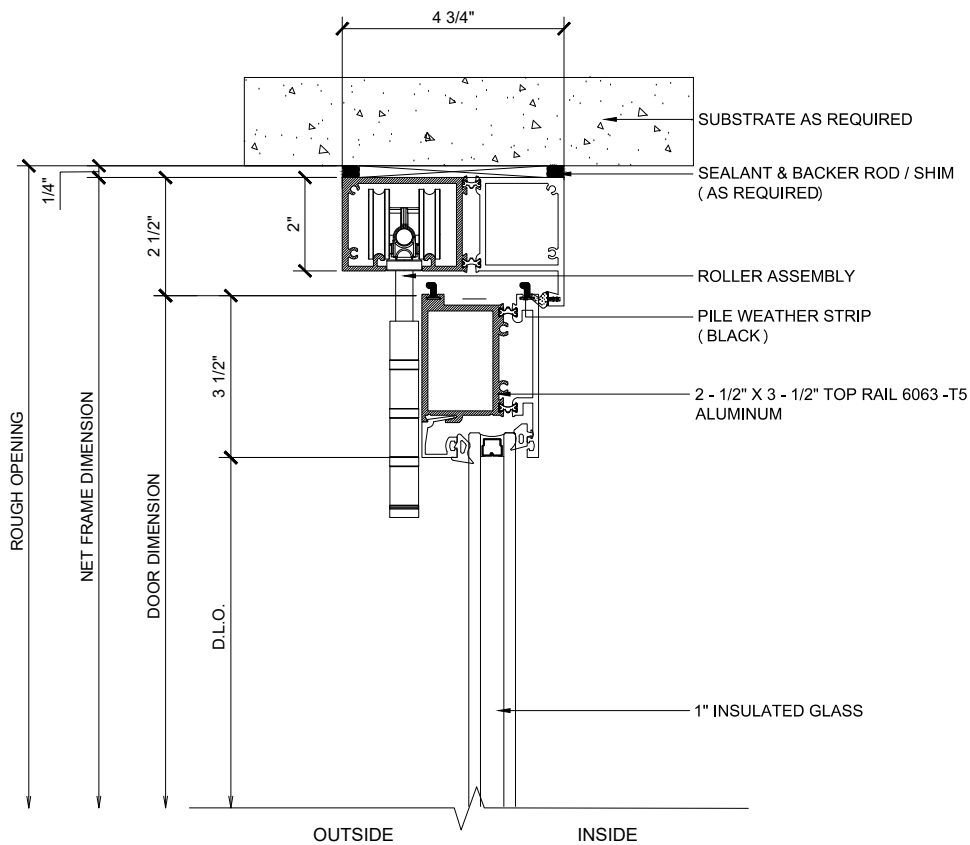

① HEAD (@DOOR)

BI-FOLD DOOR SYSTEM (X-XX) SCALE: 6"=1'-0"

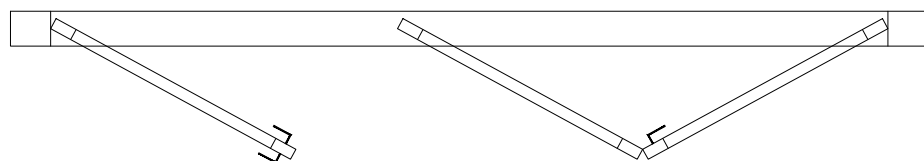

A CONFIGURATION

BI-FOLD DOOR SYSTEM (X-XX) SCALE: 6"=1'-0"

Finishes:

- Clear and Bronze anodized finishes Class 1
- Standard Mill Finish available for custom colors
- Kynar

Custom finishes available

NOTE: When using maximum panel width & height 42" x 120" panel may exceed maximum panel weight of 220 lbs, consult PRL for details.

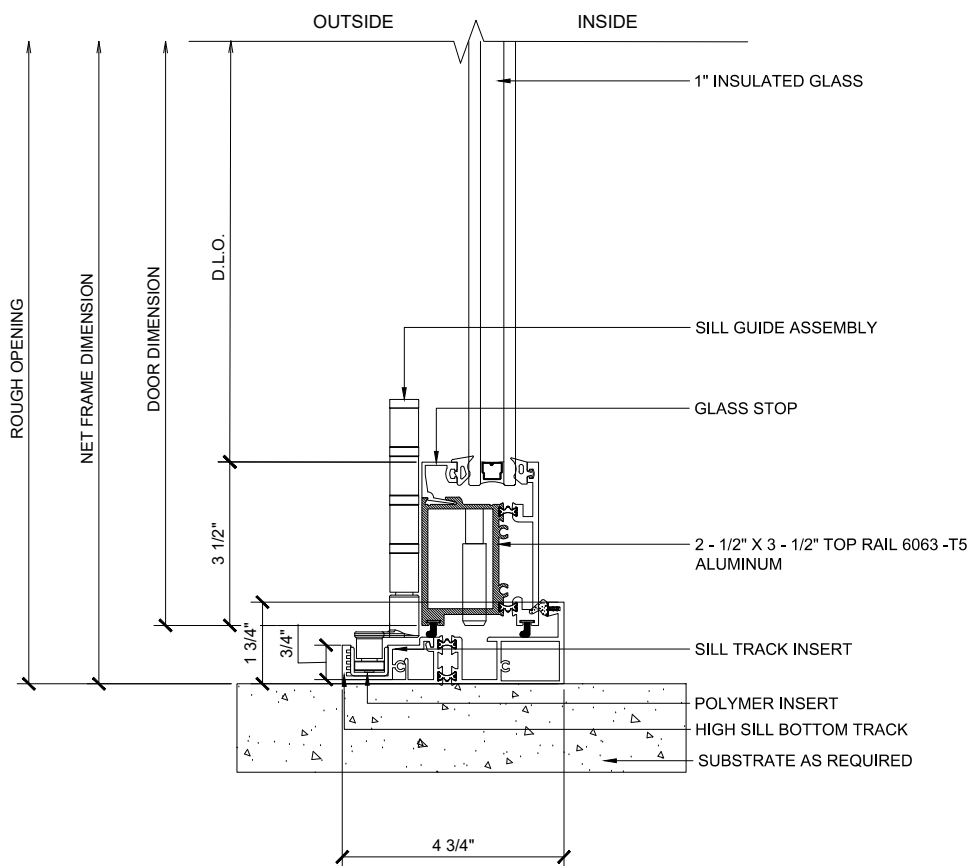

② HIGH SILL (@DOOR)

BI-FOLD DOOR SYSTEM (X-XX) SCALE: 6"=1'-0"

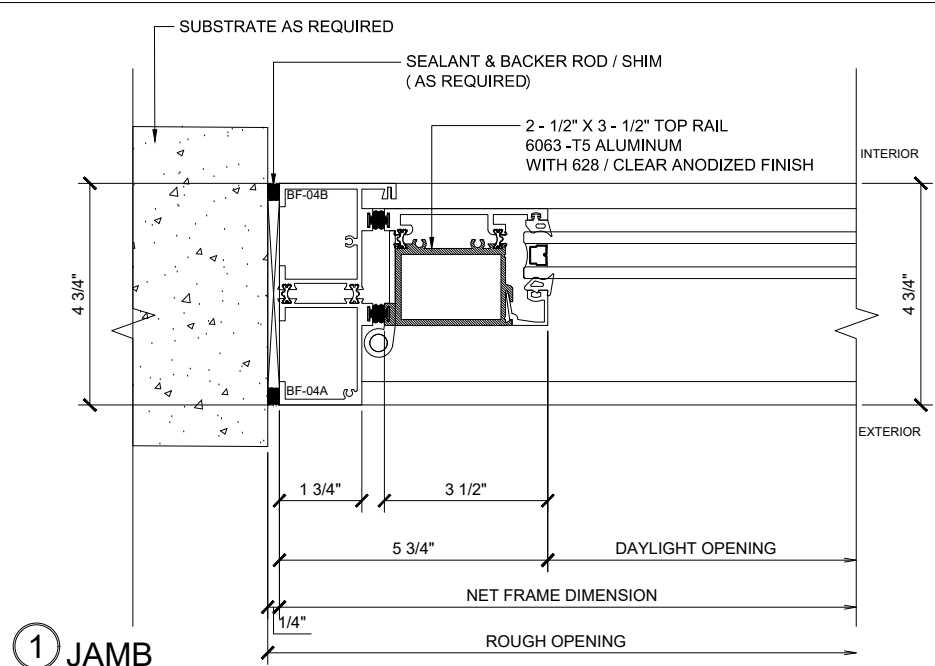

① JAMB

BI-FOLD DOOR SYSTEM (X-XX) SCALE: 6"=1'-0"

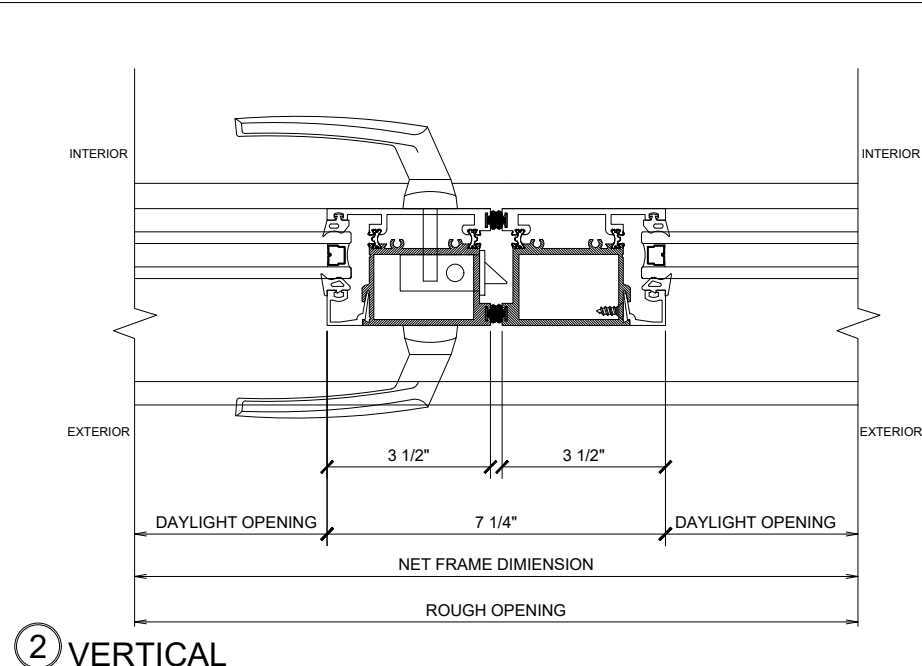

② VERTICAL

BI-FOLD DOOR SYSTEM (X-XX) SCALE: 6"=1'-0"

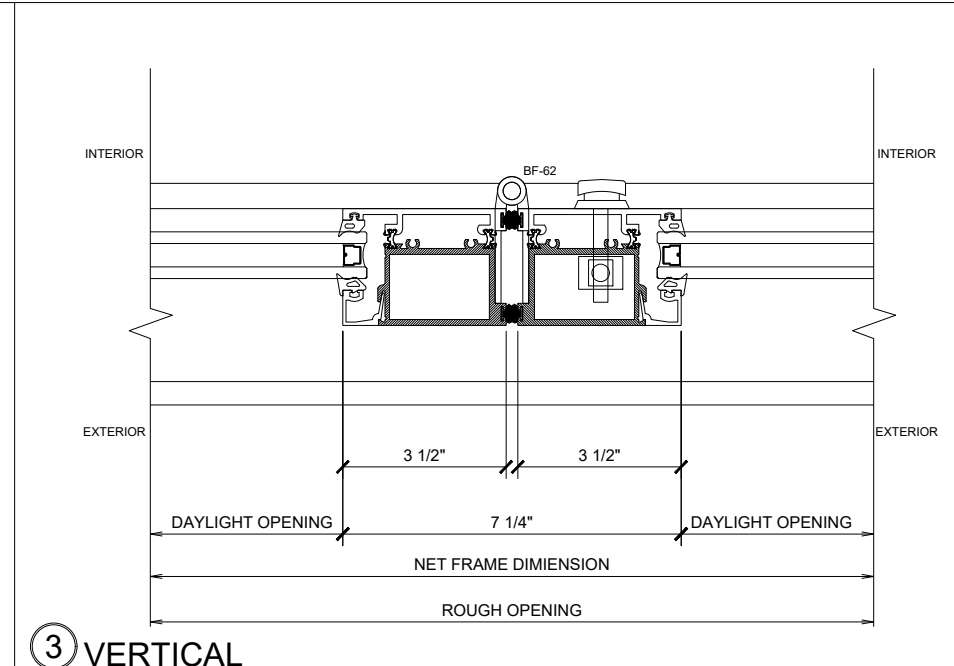

③ VERTICAL

BI-FOLD DOOR SYSTEM (X-XX) SCALE: 6"=1'-0"

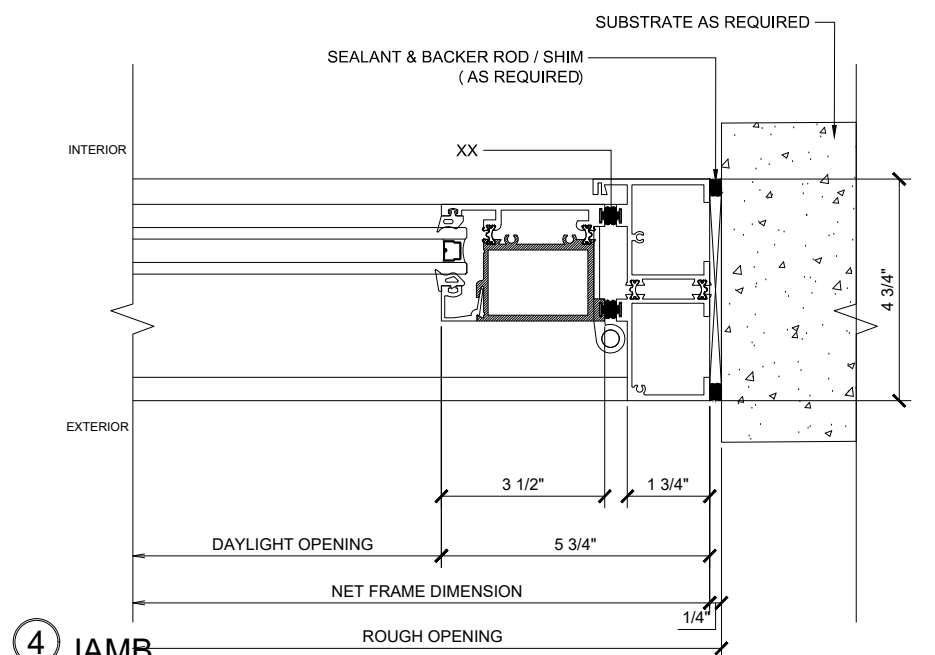

④ JAMB

BI-FOLD DOOR SYSTEM (X-XX) SCALE: 6"=1'-0"



ADDRESS: 13644 NELSON AVE. CITY OF INDUSTRY, CA.
TEL: (877) 775-25856
FAX No.: (626) 968-95256
WEBSITE: www.prl-glass.com www.prlaluminum.com

BI - FOLD NO SILL

DOOR SYSTEM IN A BI-DIRECTION (LEFT - RIGHT)
1L-2R PANELS - STACKING OUT
X - DOORS

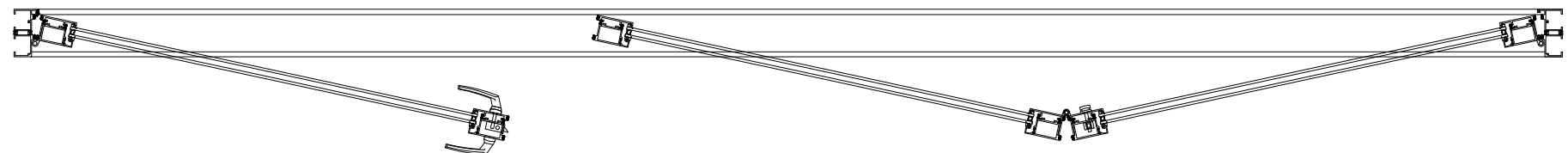
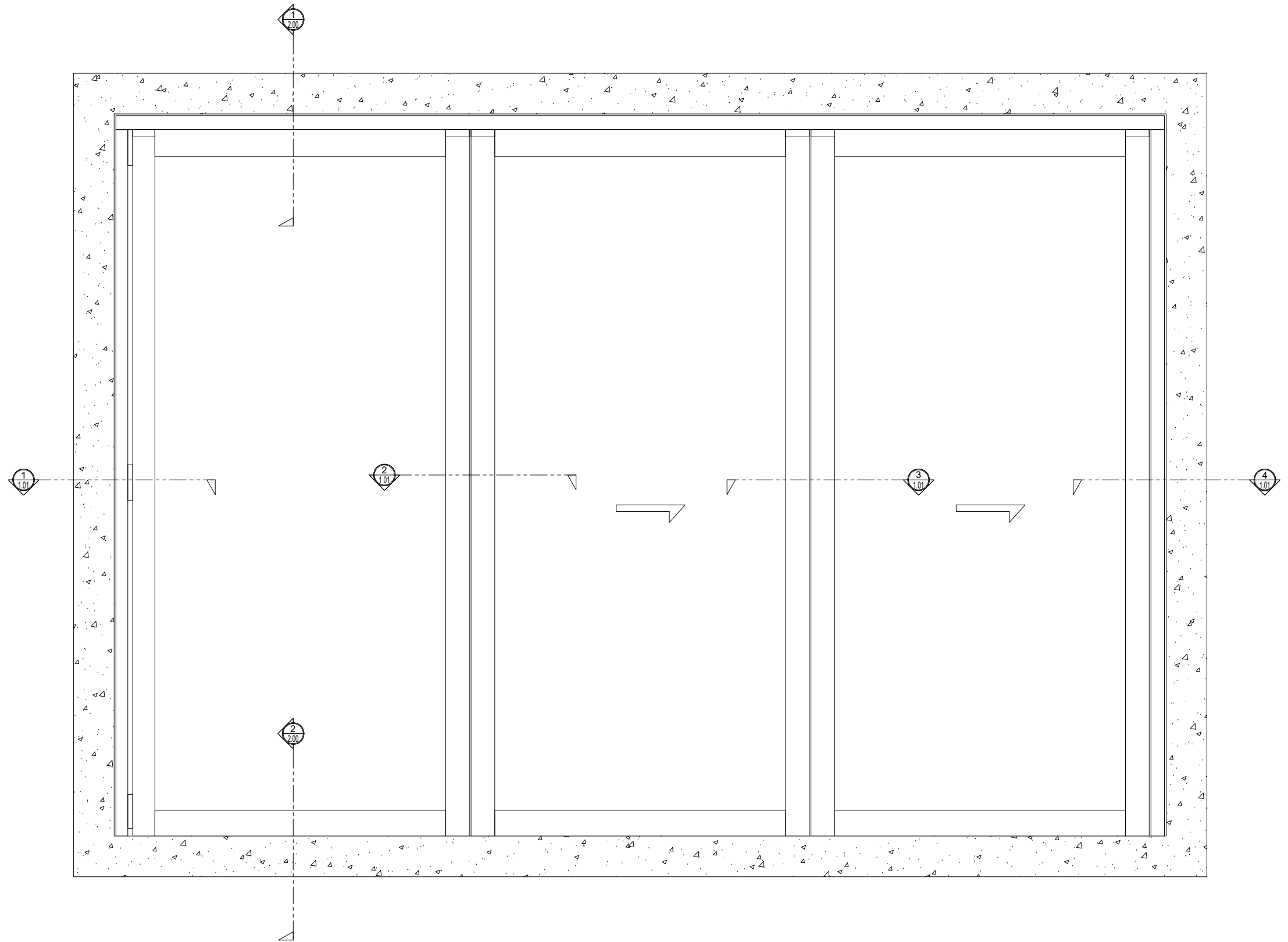
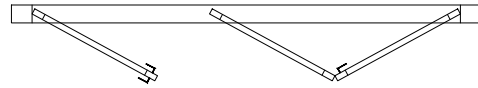

BI - FOLD

NO SILL

DOOR SYSTEM IN A BI-DIRECTION (LEFT - RIGHT)
 1L-2R PANELS - STACKING OUT
 X - DOORS

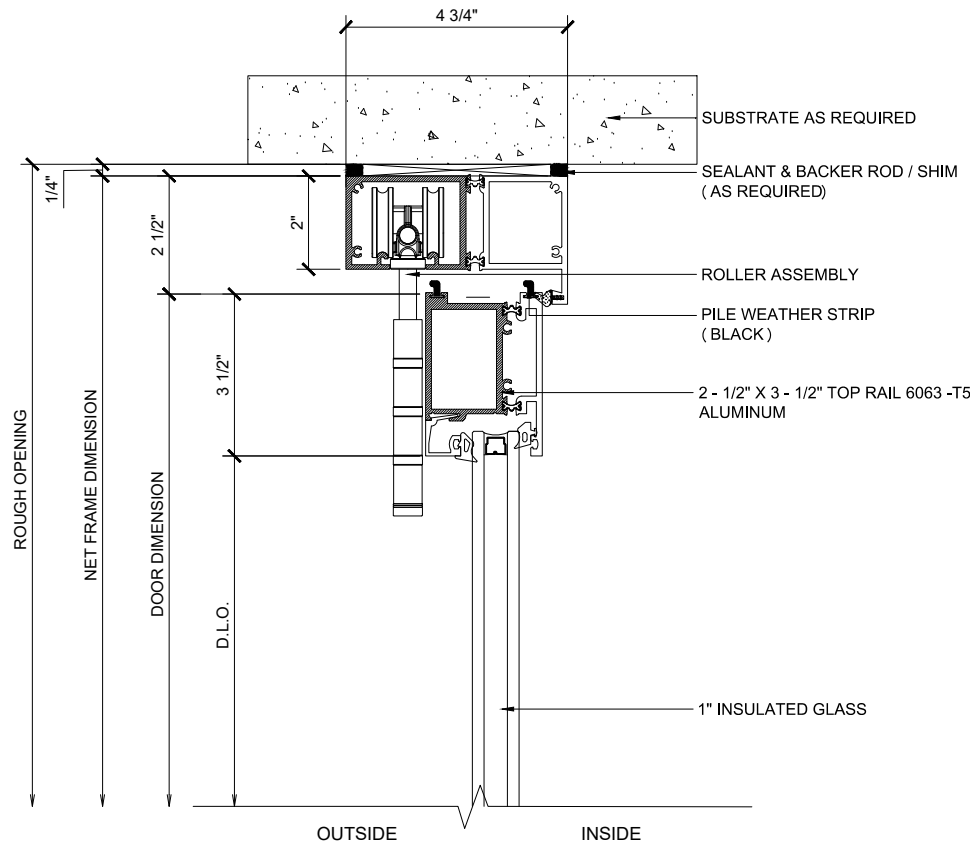

① HEAD (@DOOR)

BI-FOLD DOOR SYSTEM (X-XX) SCALE: 6"=1'-0"

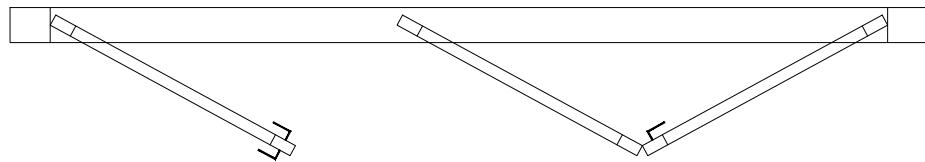

Ⓐ CONFIGURATION

BI-FOLD DOOR SYSTEM (X-XX) SCALE: 6"=1'-0"

Finishes:

- Clear and Bronze anodized finishes Class 1
- Standard Mill Finish available for custom colors
- Kynar

Custom finishes available

NOTE: When using maximum panel width & height 42" x 120" panel may exceed maximum panel weight of 220 lbs, consult PRL for details.

NO WATERPROOF

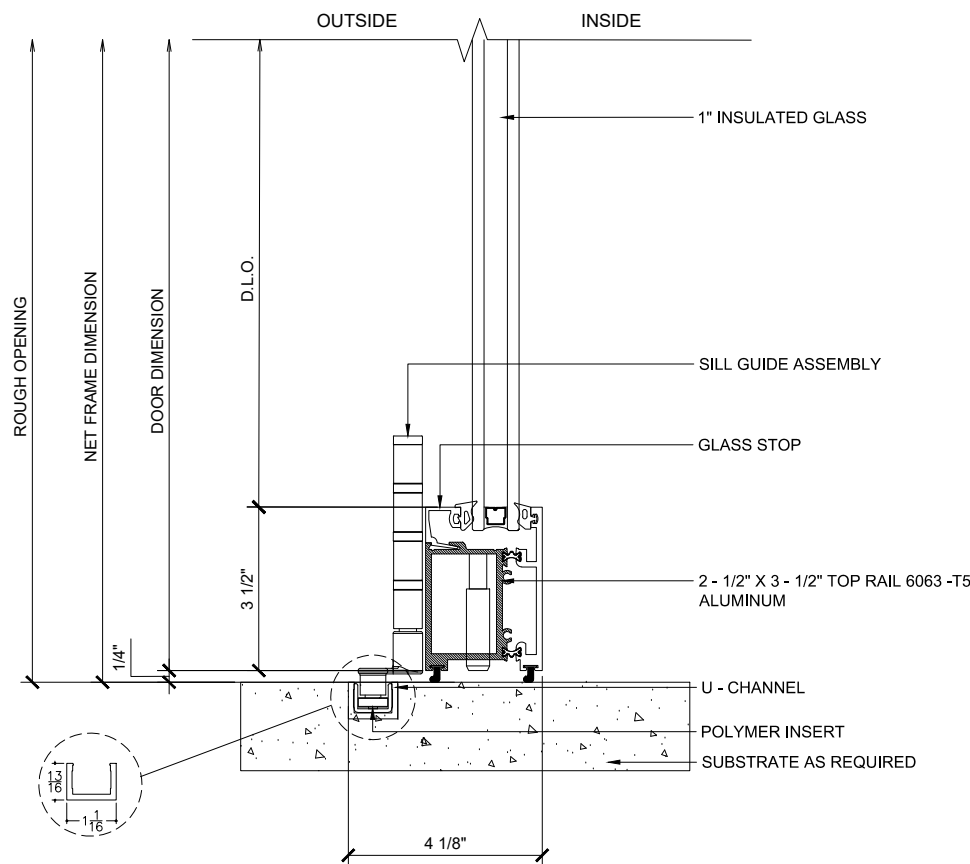

② NO SILL (@DOOR)

BI-FOLD DOOR SYSTEM (X-XX) SCALE: 6"=1'-0"



ADDRESS: 13644 NELSON AVE. CITY OF INDUSTRY, CA.
TEL: (877) 775-25856
FAX No.: (626) 968-95256
WEBSITE: www.prl-glass.com www.prlaluminum.com

BI - FOLD

LOW SILL

DOOR SYSTEM IN A BI-DIRECTION (LEFT - RIGHT)
1L-2R PANELS - STACKING OUT
X - DOORS

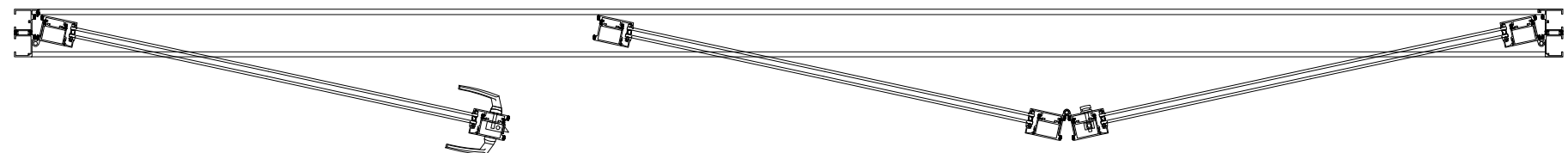
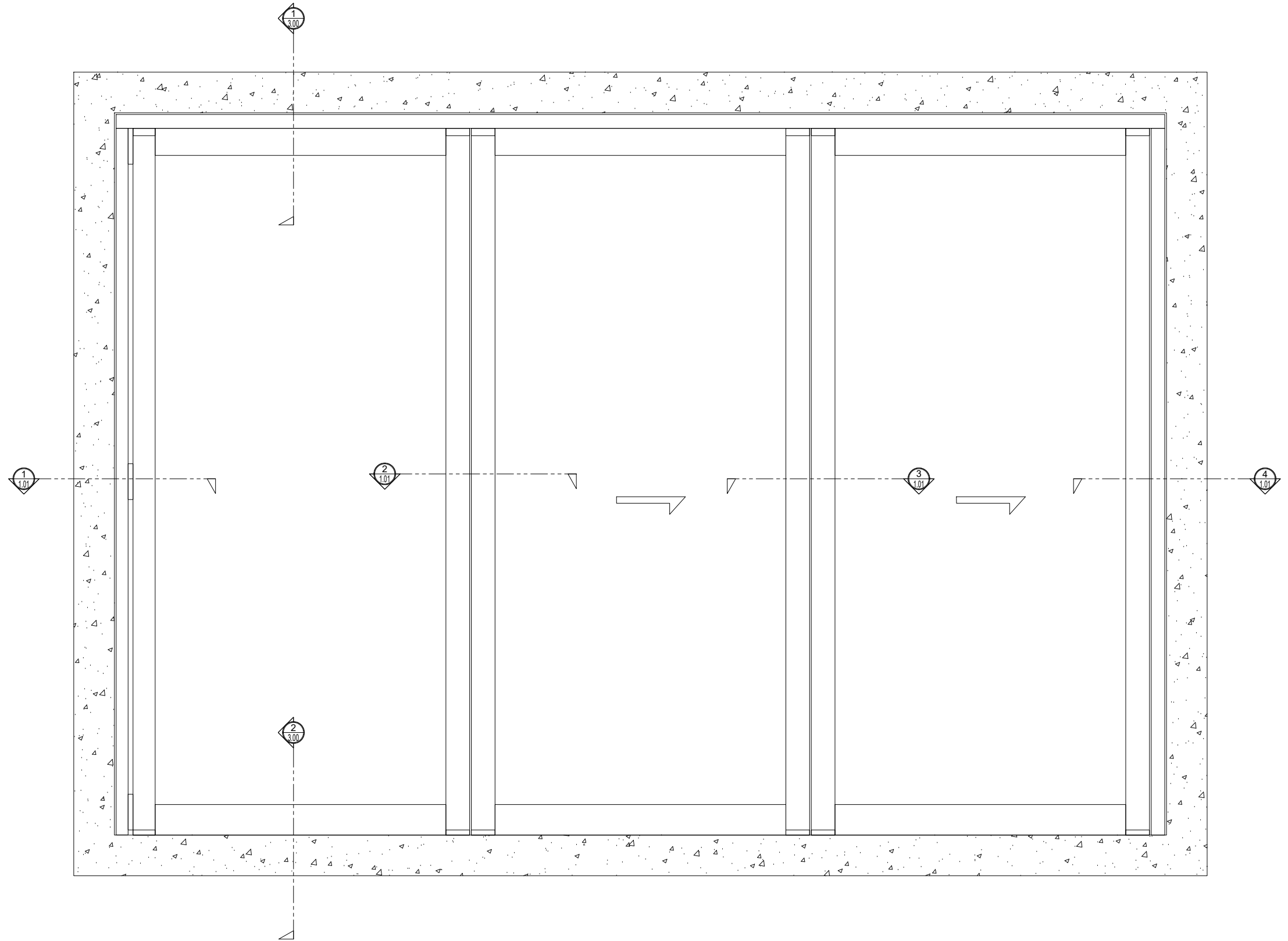
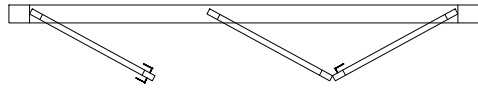

BI - FOLD

LOW SILL

DOOR SYSTEM IN A BI-DIRECTION (LEFT - RIGHT)
 1L-2R PANELS - STACKING OUT
 X - DOORS

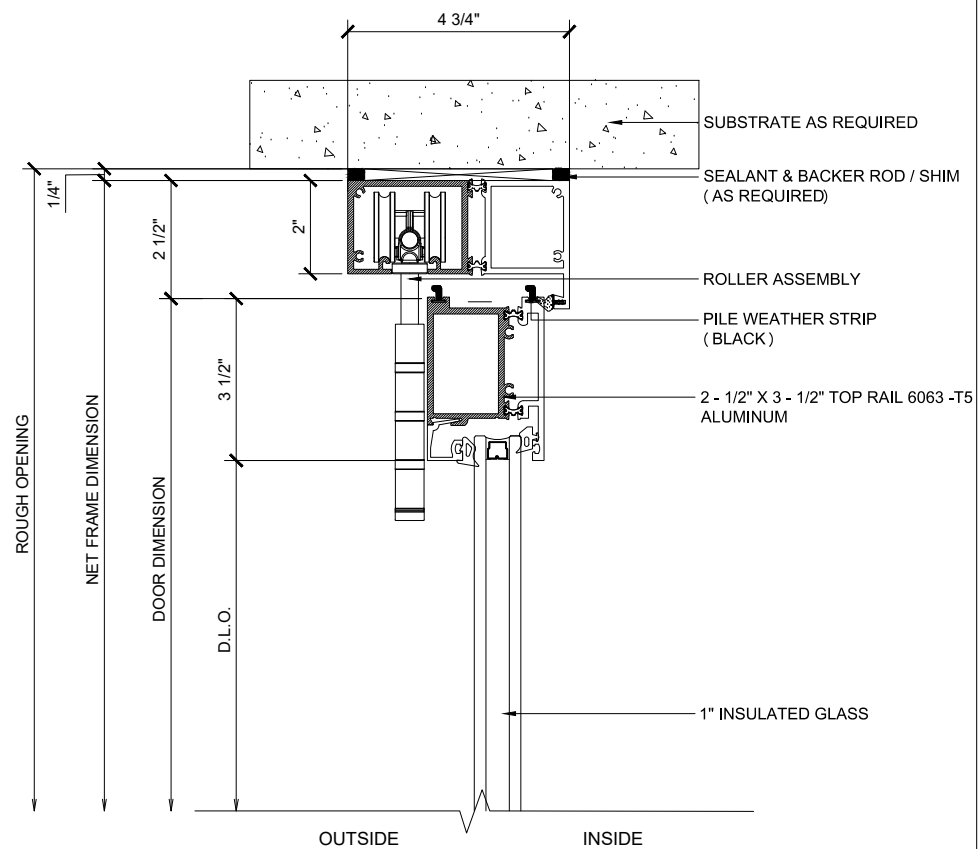

① HEAD (@DOOR)

BI-FOLD DOOR SYSTEM (X-XX) SCALE: 6"=1'-0"

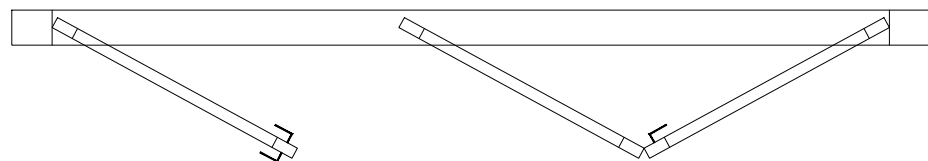

Ⓐ CONFIGURATION

BI-FOLD DOOR SYSTEM (X-XX) SCALE: 6"=1'-0"

Finishes:

- Clear and Bronze anodized finishes Class 1
- Standard Mill Finish available for custom colors
- Kynar

Custom finishes available

NOTE: When using maximum panel width & height 42" x 120" panel may exceed maximum panel weight of 220 lbs, consult PRL for details.

NO WATERPROOF

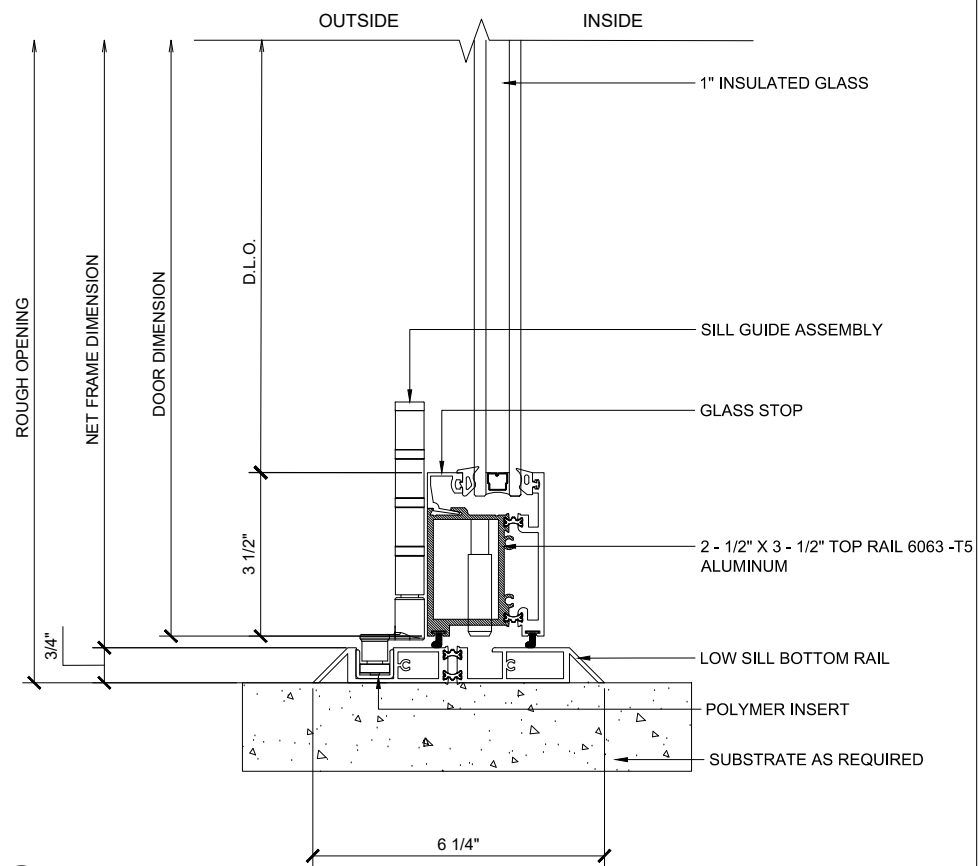

② LOW SILL (@DOOR)

BI-FOLD DOOR SYSTEM (X-XX) SCALE: 6"=1'-0"

BI - FOLD

ADA SILL

DOOR SYSTEM IN A BI-DIRECTION (LEFT - RIGHT)
1L-2R PANELS - STACKING OUT
X - DOORS

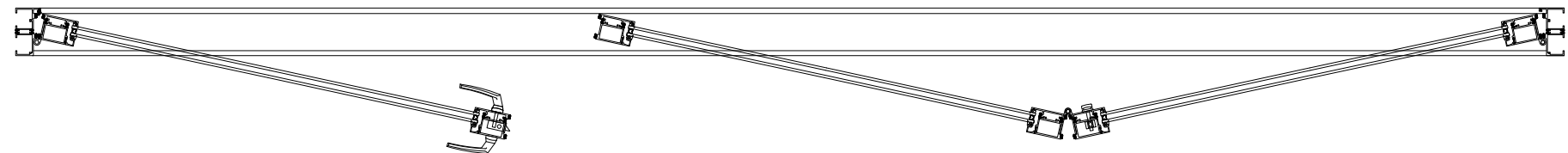
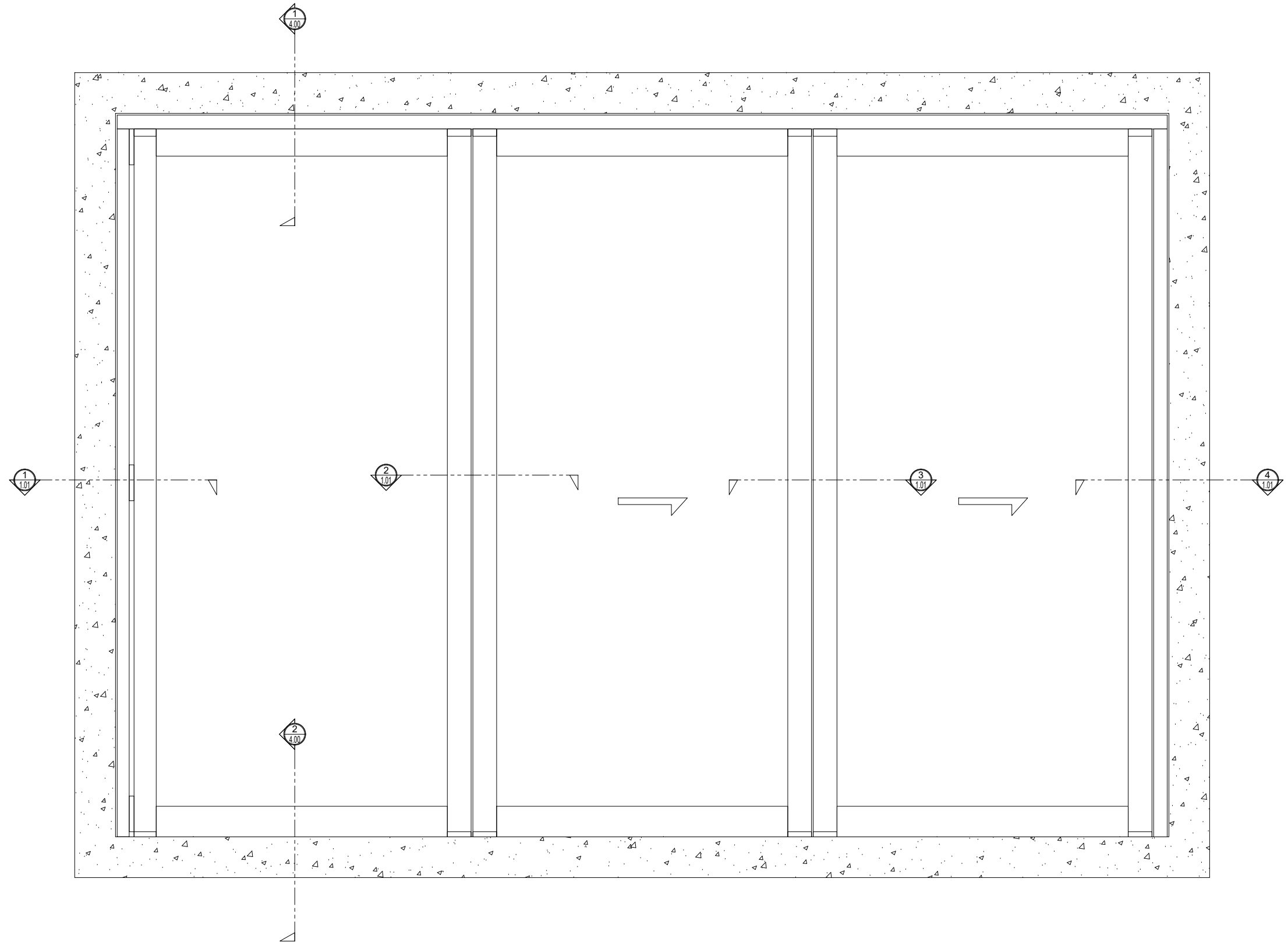
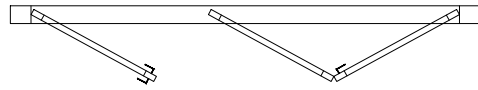

BI - FOLD

ADA SILL

DOOR SYSTEM IN A BI-DIRECTION (LEFT - RIGHT)
 1L-2R PANELS - STACKING OUT
 X - DOORS

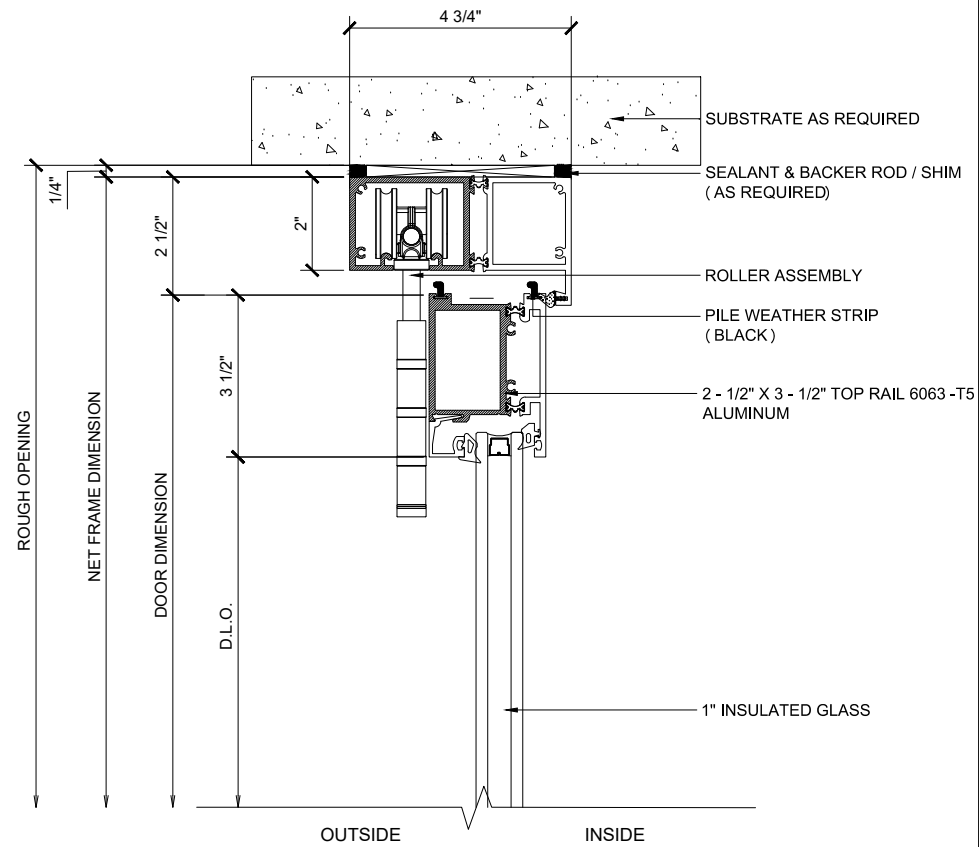

① HEAD (@DOOR)

BI-FOLD DOOR SYSTEM (X-XX) SCALE: 6"=1'-0"

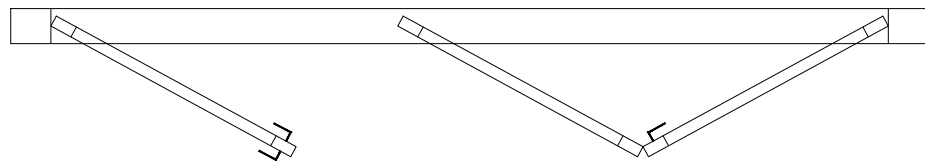

Ⓐ CONFIGURATION

BI-FOLD DOOR SYSTEM (X-XX) SCALE: 6"=1'-0"

Finishes:

- Clear and Bronze anodized finishes Class 1
- Standard Mill Finish available for custom colors
- Kynar

Custom finishes available

NOTE: When using maximum panel width & height 42" x 120" panel may exceed maximum panel weight of 220 lbs, consult PRL for details.

NO WATERPROOF

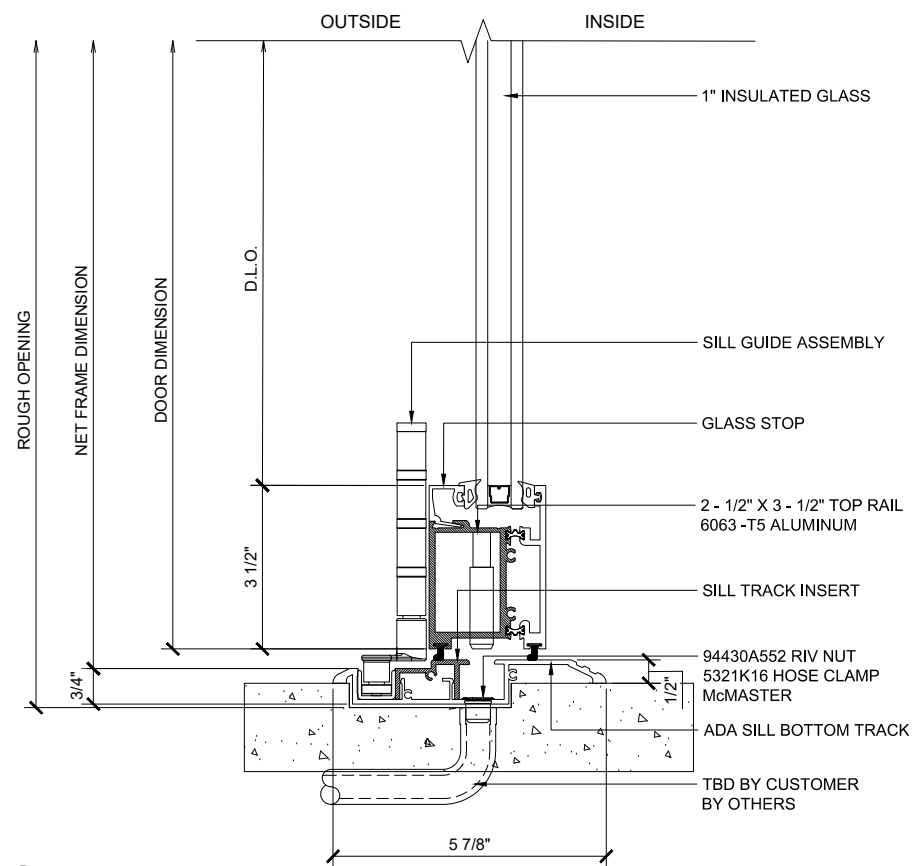

② ADA SILL (@DOOR)

BI-FOLD DOOR SYSTEM (X-XX) SCALE: 6"=1'-0"