

Specifications

In a single direction:

- Maximum Panel Weight -220 lbs each panel
- Minimum Panel Width -24"
- Maximum Panel Width - 42"
- Maximum Panel Height -120"
- Door Thickness - 2 1/2"
- Maximum # of Doors: 8 each way = 16 panels = 45 ft total.

Extrusions: Aluminum 6063-T5.

Finishes:

- Clear and Bronze anodized finishes Class 1
- Standard Mill Finish available for custom colors
- Powder Coat/White
- Custom finishes available
- Wood Grain finishes available

Hardware: Stainless Steel Components.

Lever Lock Sets: A Set- 316 Stainless Steel, B Set- Powder Coat over Brass.

Multi-point Door Locks: Faceplate, latch and hooks

NOTE: When using maximum panel width & height 42" x 120" panel may exceed maximum panel weight of 220 lbs, consult PRL for details. Panel heights of 120" and over may fall under the weight restrictions.

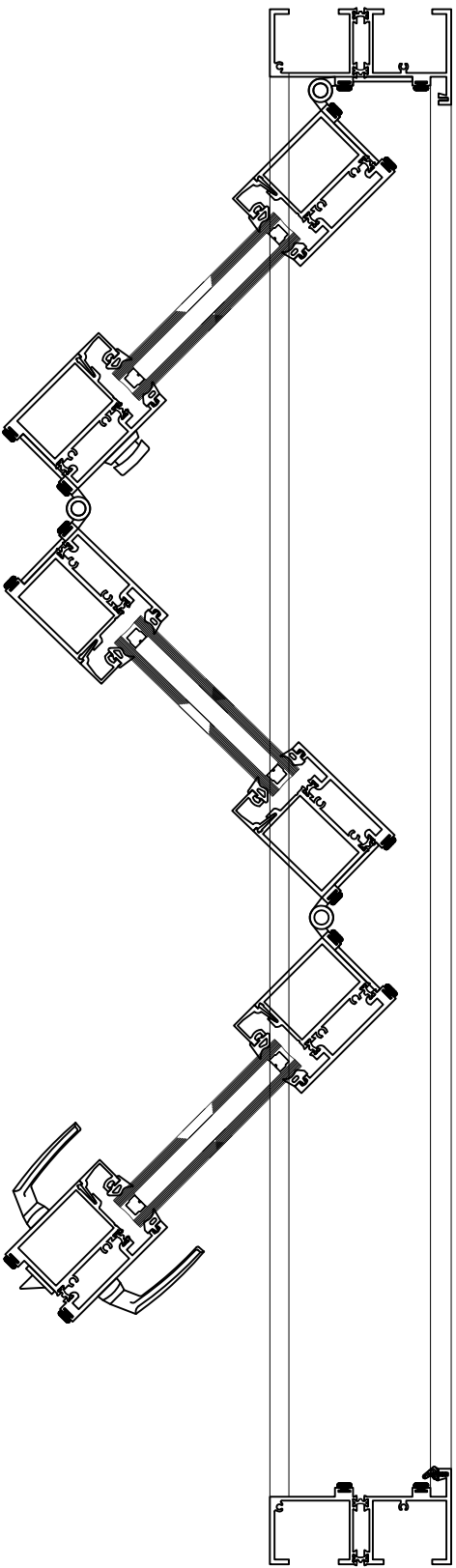

PRL BI-FOLD DOOR

Telephone : (877) 775-2666
 Fax No. : (626) 988-0256
 www.prlglass.com www.optilum.com

261 Mason Way
 City of Industry, CA

2L

INTERIOR

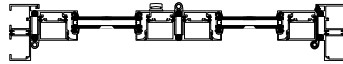
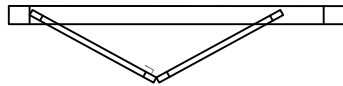

EXTERIOR

2R

INTERIOR

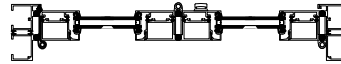
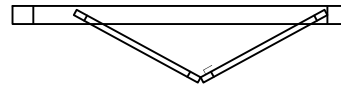

EXTERIOR

1L 2R

INTERIOR

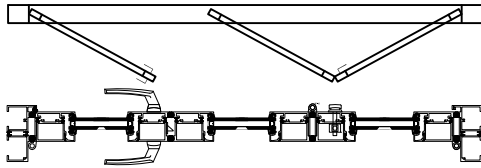

EXTERIOR

2L 1R

INTERIOR

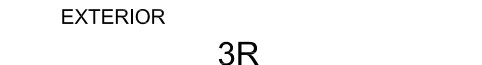
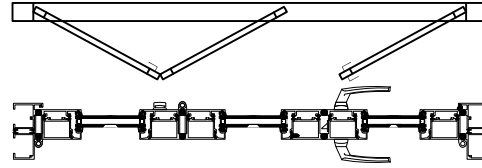

EXTERIOR

3L

INTERIOR

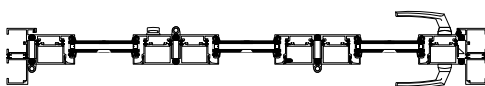
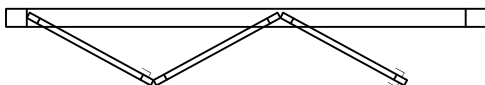

EXTERIOR

3R

INTERIOR

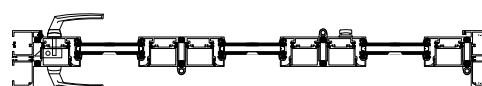
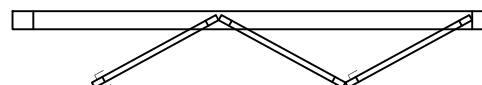

EXTERIOR

2L-2R

INTERIOR

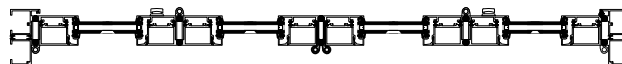
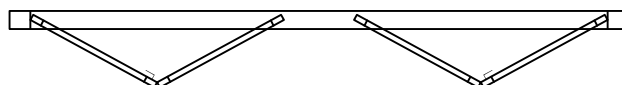

EXTERIOR

INTERIOR

EXTERIOR

3L 1R

INTERIOR

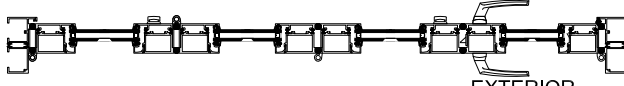
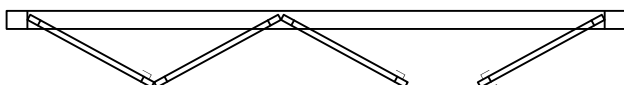

EXTERIOR

1L 3R

INTERIOR

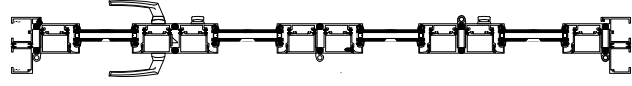
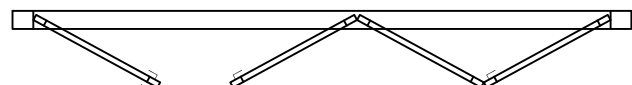

EXTERIOR

4L

INTERIOR

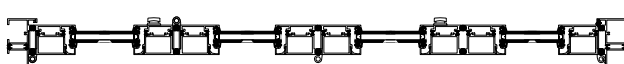
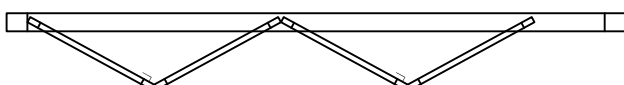

EXTERIOR

4R

INTERIOR

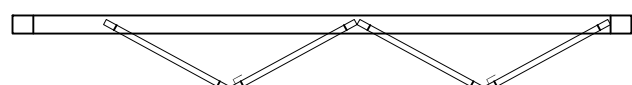

EXTERIOR

CONFIGURATIONS

PRL BI-FOLD DOOR SYSTEM



PRL BI-FOLD DOOR

1800-227-7426 271 Main Street
P.O. Box 200000 46000 Santa Fe, NM
www.prl.com 505-824-4444

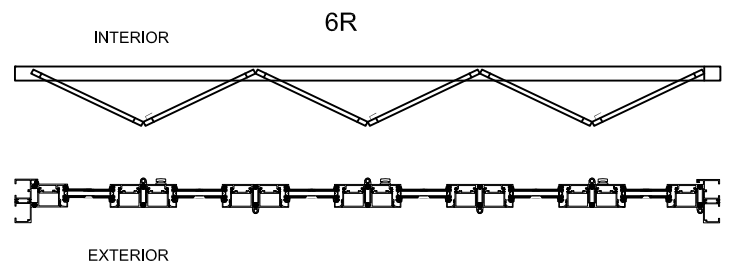
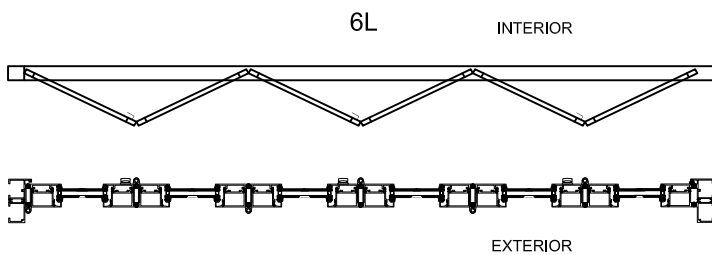
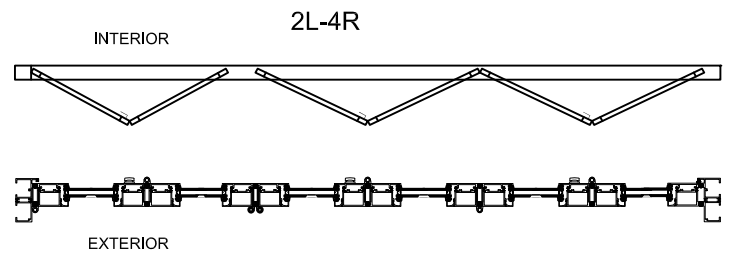
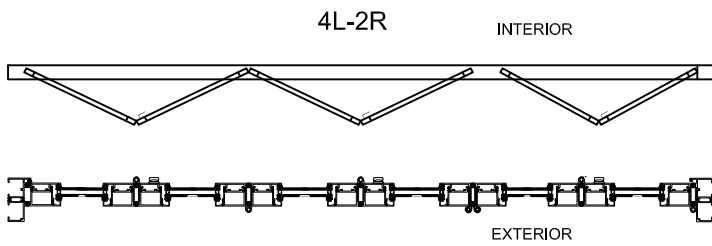
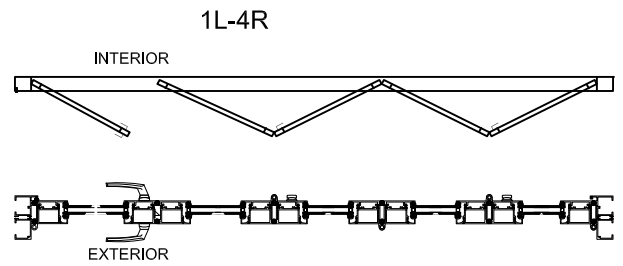
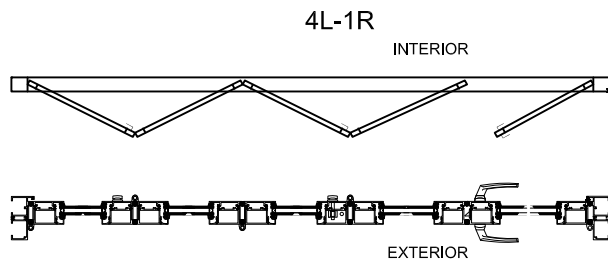
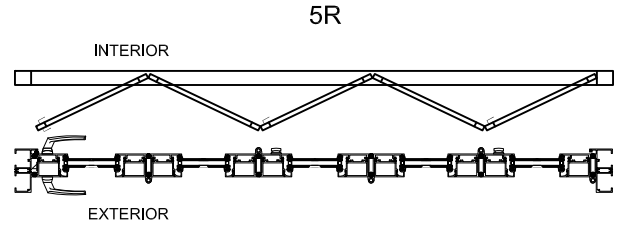
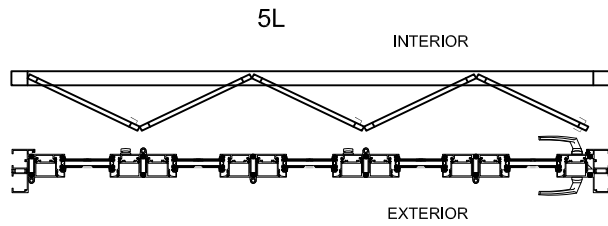

1L-6R

INTERIOR

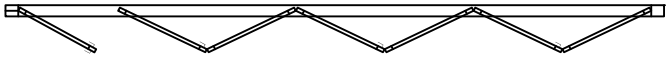

INTERIOR

6L-1R



EXTERIOR

EXTERIOR

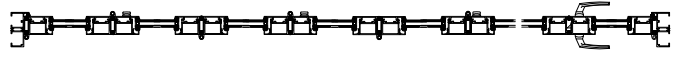

3L-4R

INTERIOR



INTERIOR

4L-3R

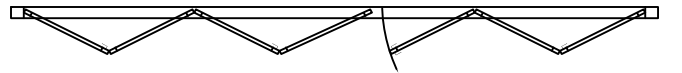

EXTERIOR

EXTERIOR

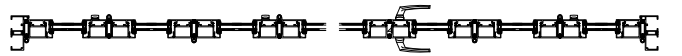
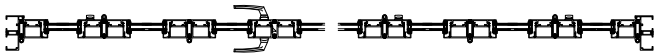

7L

INTERIOR



INTERIOR

7R

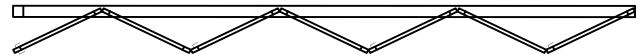

EXTERIOR

EXTERIOR



8L

INTERIOR



INTERIOR

8R



EXTERIOR

EXTERIOR

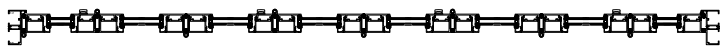

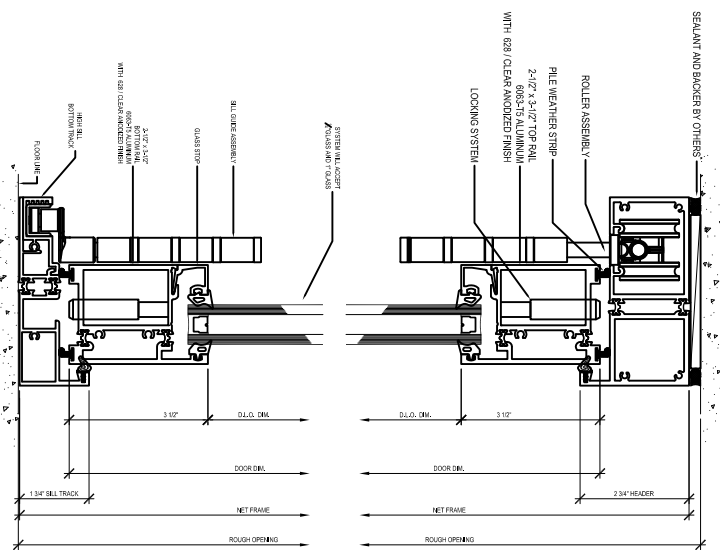
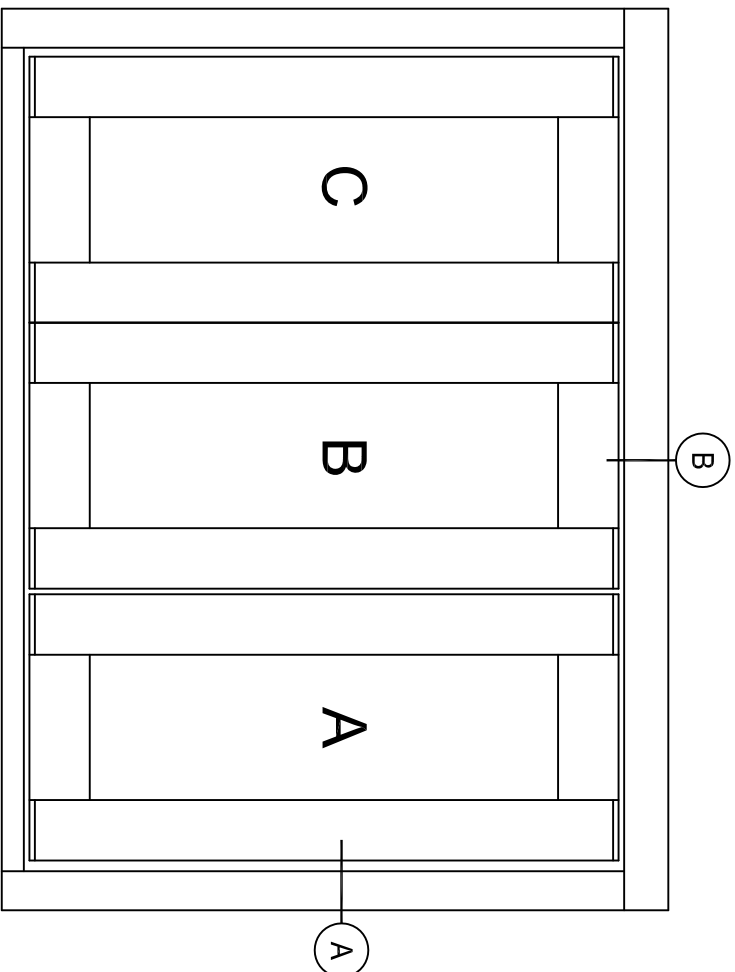

B Section @ (DOORS)
PRL BI-FOLD DOOR SYSTEM

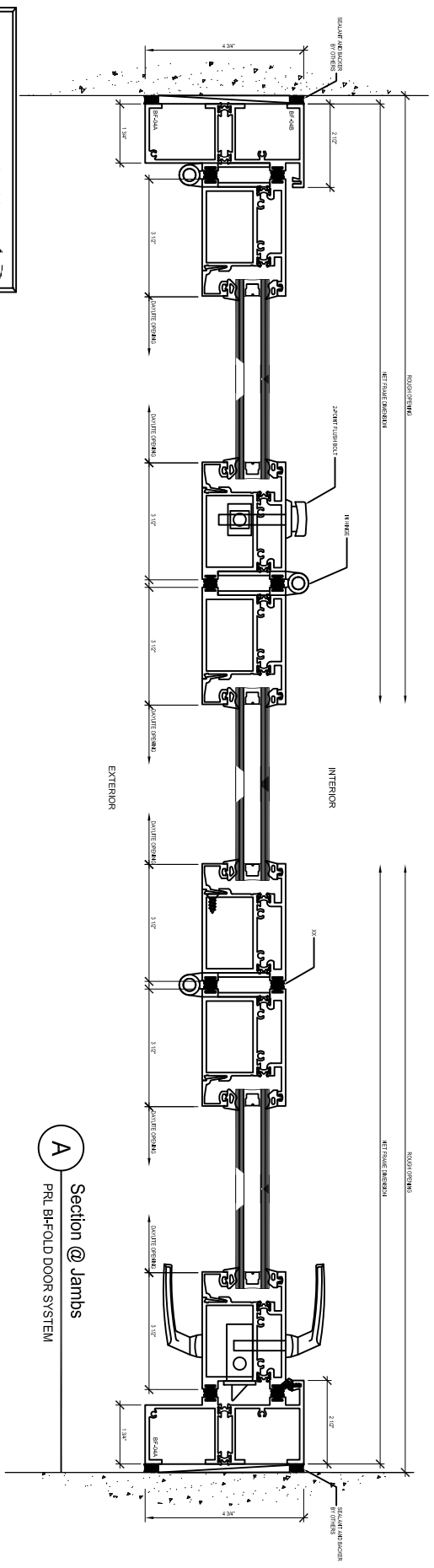

A Section @ Jamb
PRL BI-FOLD DOOR SYSTEM

PRL GLASS SYSTEMS INC.
251 Mason Way
City of Industry, CA
Telephone : (877) 775-2586
Fax No. : (626) 968-9526
www.prl-glass.com www.prlaluminum.com

BI-FOLD PRL BI-FOLD DOOR
3-L PANELS- STACKING OUT

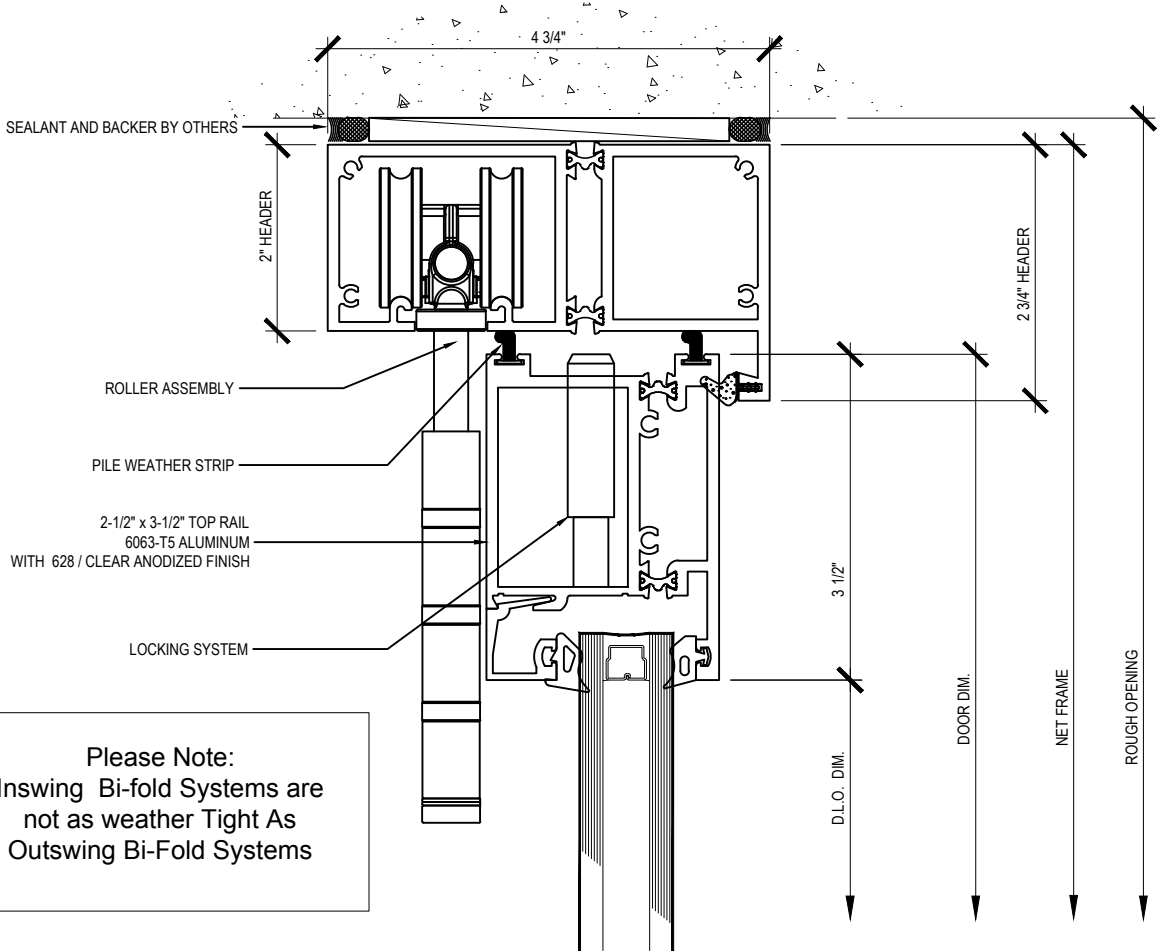

Please Note:
 Inswing Bi-fold Systems are
 not as weather Tight As
 Outswing Bi-Fold Systems

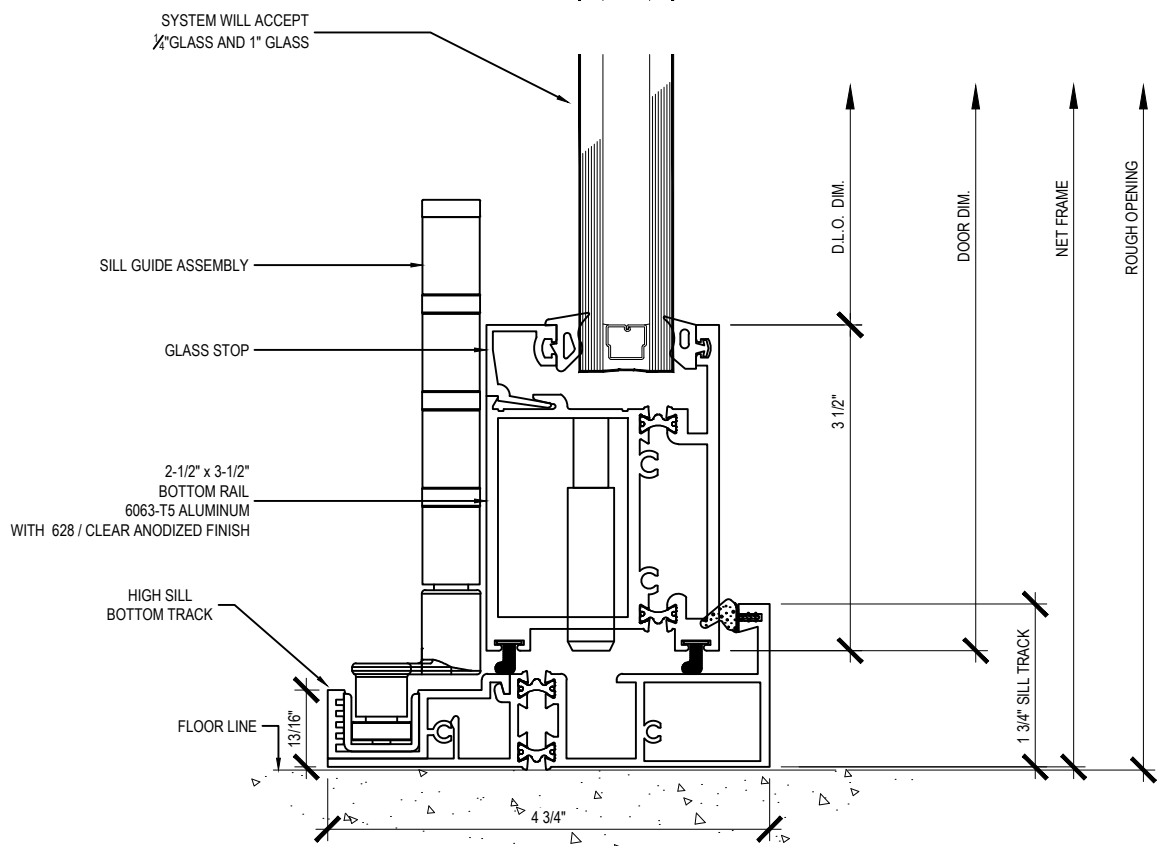

B

Section @ (DOORS)

PRL BI-FOLD DOOR SYSTEM

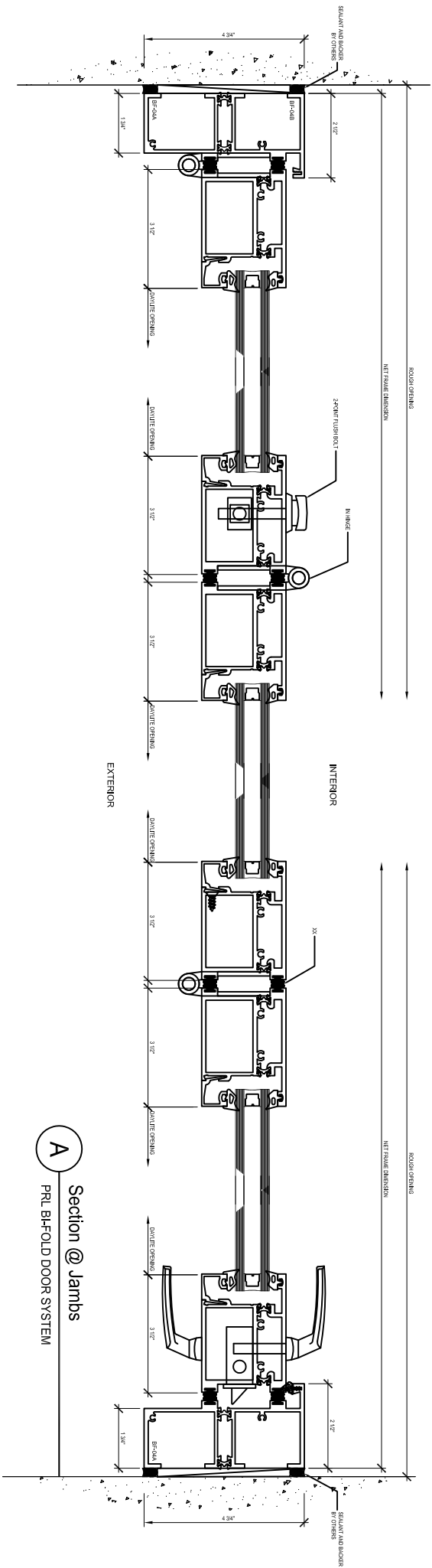

A Section @ Jamb
 PRL BI-FOLD DOOR SYSTEM



PRL BI-FOLD

Telephone : (877) 775-2586
 Fax No. : (626) 968-9526
 www.prlglass.com www.phaluminum.com
 251 Mason Way
 City of Industry, C.A.

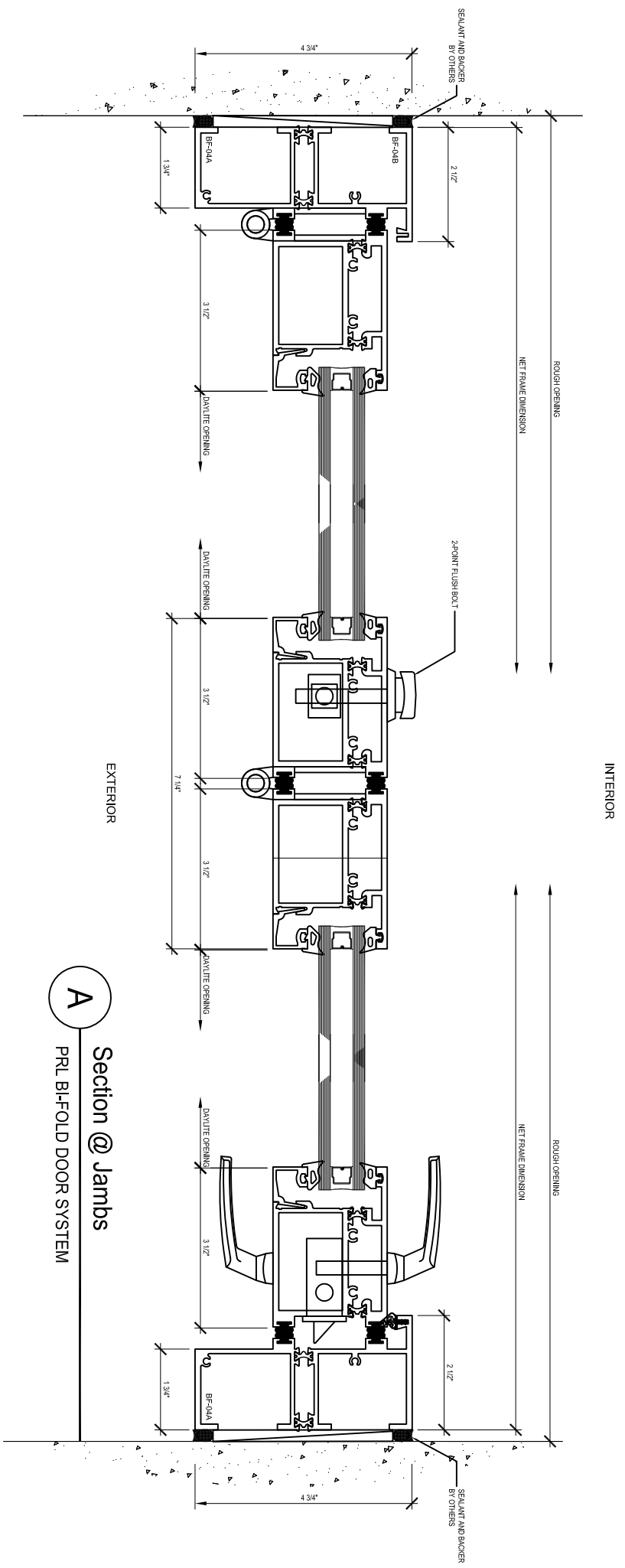

A
 Section @ Jamb
 PRL BI-FOLD DOOR SYSTEM

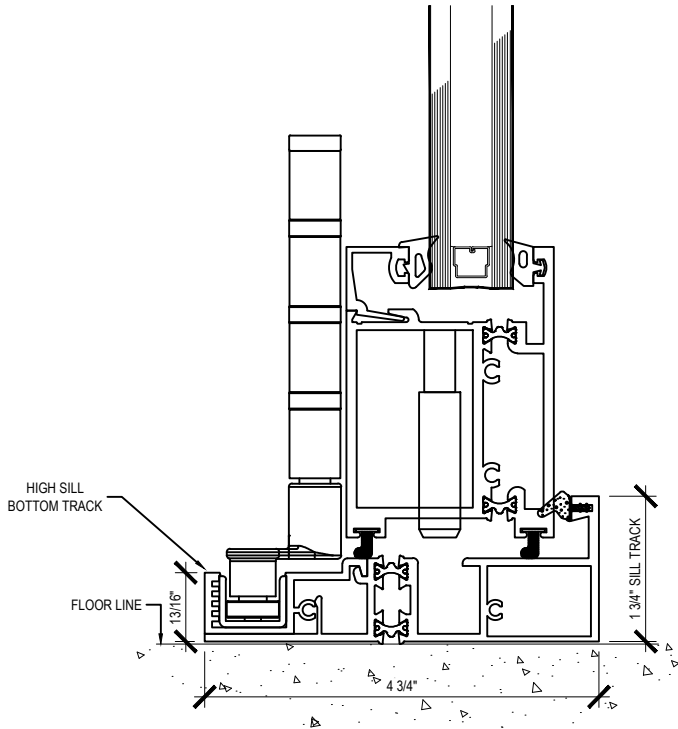

HIGH SILL

PRL BI-FOLD DOOR SYSTEM

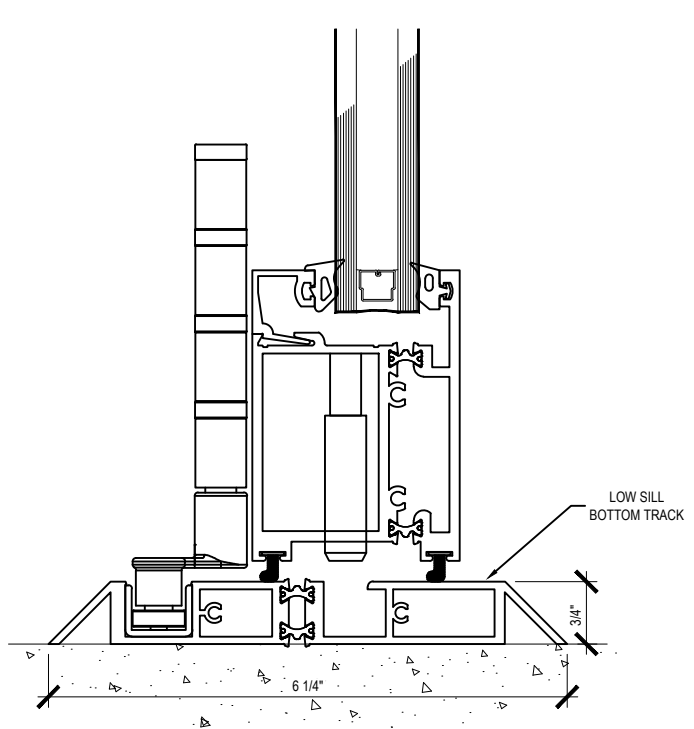

LOW SILL

PRL BI-FOLD DOOR SYSTEM

Please Note:
 Low Sill is not weather Tight As High Sill, Not Recommended for **Exterior** applications.

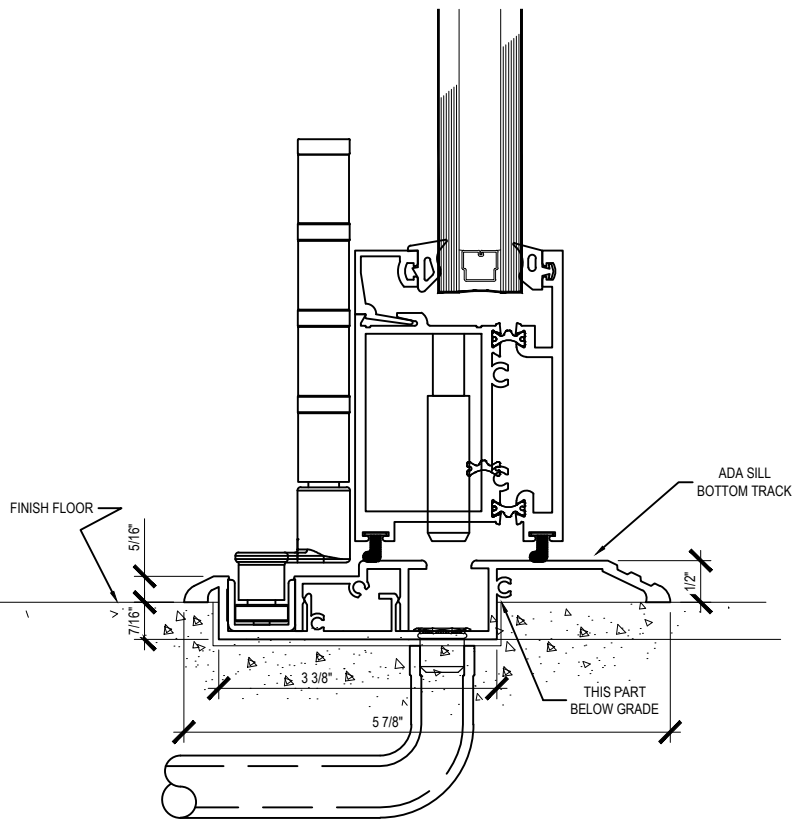

ADA SILL

PRL BI-FOLD DOOR SYSTEM

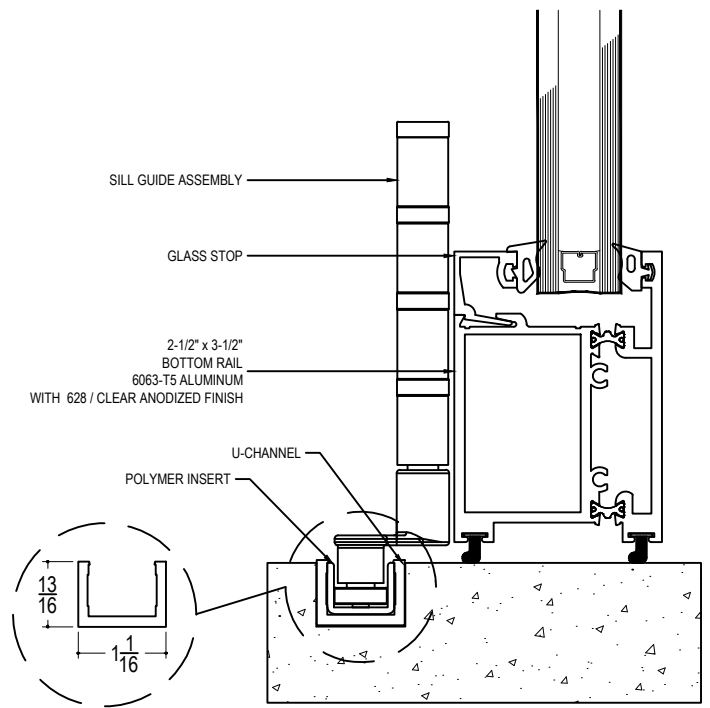

Please Note:
 Not Recommended for **Exterior** applications.

NO SILL

PRL BI-FOLD DOOR SYSTEM