

# BP-STYLE DOOR

## 9 1/2" PL150DS TOP PL150DS BOTTOM

\* FINISHES AVAILABLE :  
# 8 POLISHED & # 4 SATIN  
STAINLESS  
US3 POLISHED & US4 SATIN  
BRASS ( NON LACQUER COATED)  
US10B  
ANODIZED PAINTED

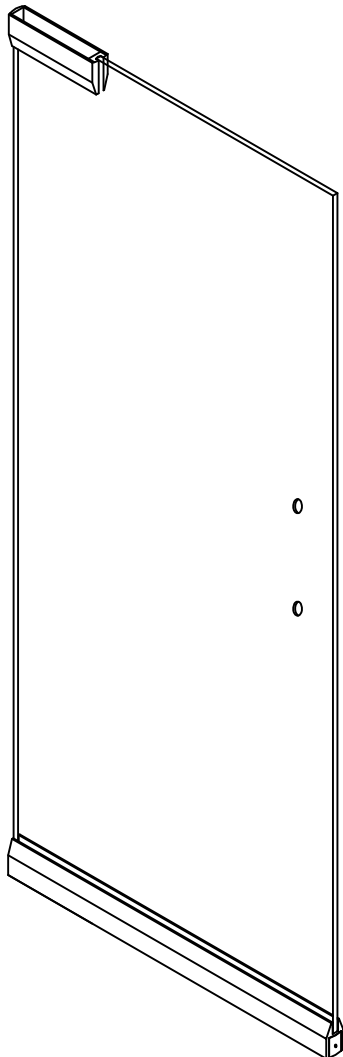

9 1/2" PL-150DS TOP PATCH RAIL  
(CLAD) BY P.R.L. GLASS

1/2" CLEAR TEMPERED GLASS  
BY P.R.L. GLASS

PL-150DS  
BTM RAIL (CLAD)  
BY P.R.L. GLASS

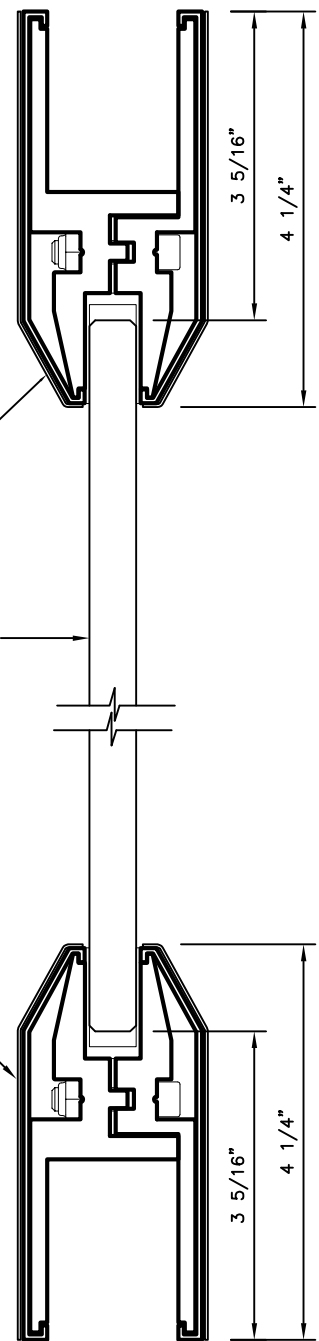

# BP-STYLE DOOR

## 9 1/2" PL175DS TOP PL175DS BOTTOM

\* FINISHES AVAILABLE :  
# 8 POLISHED & # 4 SATIN  
STAINLESS  
US3 POLISHED & US4 SATIN  
BRASS ( NON LACQUER COATED )  
US10B  
ANODIZED PAINTED

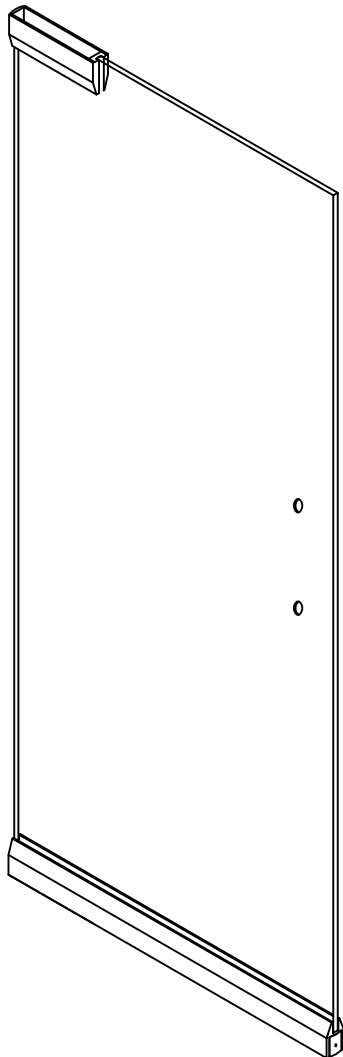

9 1/2" PL-175DS TOP PATCH RAIL  
(CLAD) BY P.R.L. GLASS

3/4" CLEAR TEMPERED GLASS  
BY P.R.L. GLASS

PL-175DS  
BTM RAIL (CLAD)  
BY P.R.L. GLASS

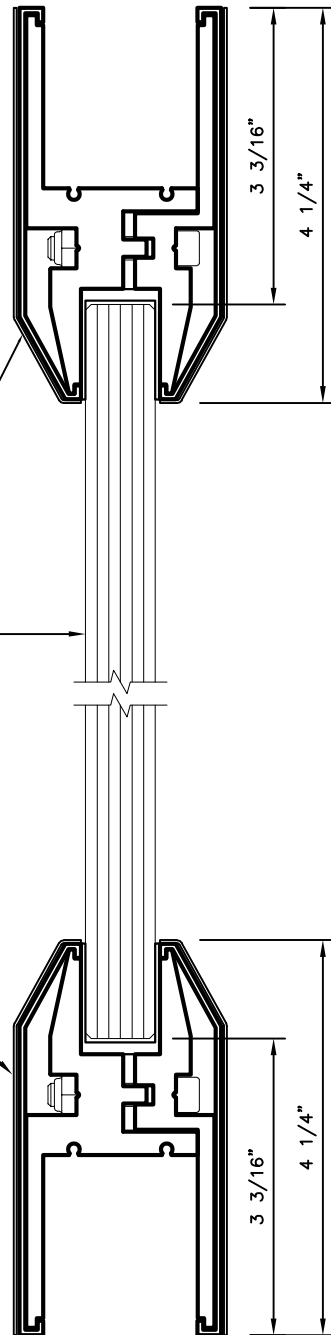

# BP-STYLE DOOR

9 1/2" PL175DS TOP  
PL175DS BOTTOM

\* FINISHES AVAILABLE :  
# 8 POLISHED & # 4 SATIN  
STAINLESS  
US3 POLISHED & US4 SATIN  
BRASS ( NON LACQUER COATED )  
US10B  
ANODIZED PAINTED

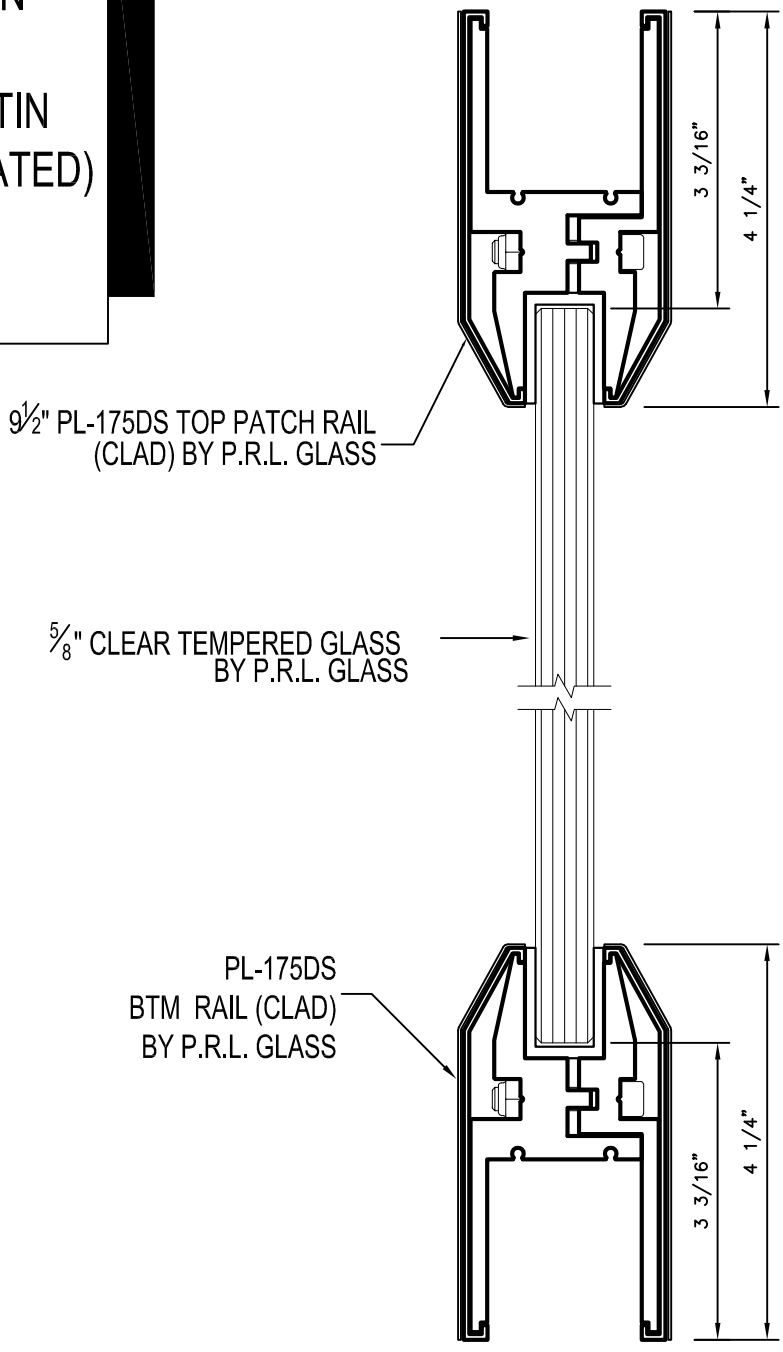
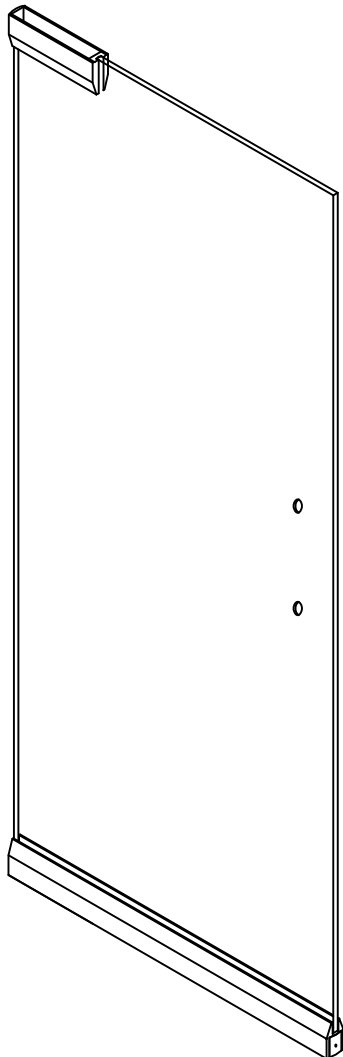

# BP-STYLE DOOR

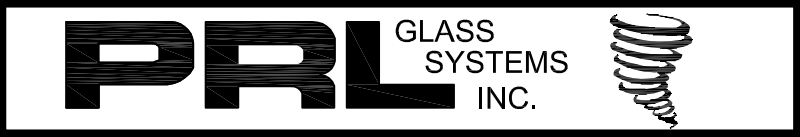

## 9 1/2" PL350DS TOP PL350DS BOTTOM

\* FINISHES AVAILABLE :  
# 8 POLISHED & # 4 SATIN  
STAINLESS  
US3 POLISHED & US4 SATIN  
BRASS ( NON LACQUER COATED)  
US10B  
ANODIZED PAINTED

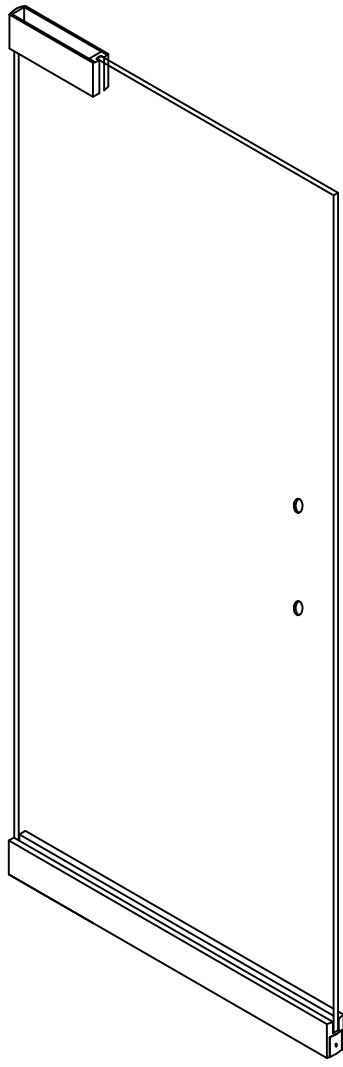

9 1/2" PL-350DS TOP PATCH RAIL  
(CLAD) BY P.R.L. GLASS

1/2" CLEAR TEMPERED GLASS  
BY P.R.L. GLASS

PL-350DS BTM RAIL  
(CLAD)  
BY P.R.L. GLASS

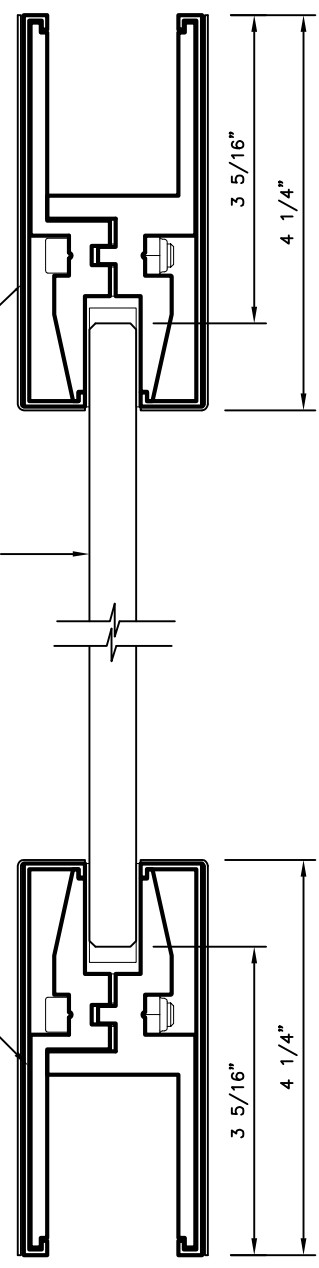

# BP-STYLE DOOR

## 9 1/2" PL350DS TOP PL1000DS BOTTOM

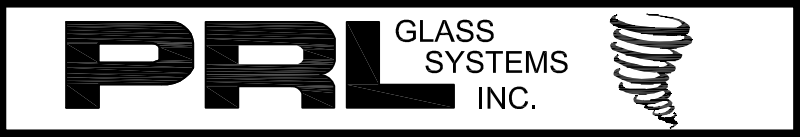

\* FINISHES AVAILABLE :  
# 8 POLISHED & # 4 SATIN  
STAINLESS  
US3 POLISHED & US4 SATIN  
BRASS ( NON LACQUER COATED )  
US10B  
ANODIZED PAINTED

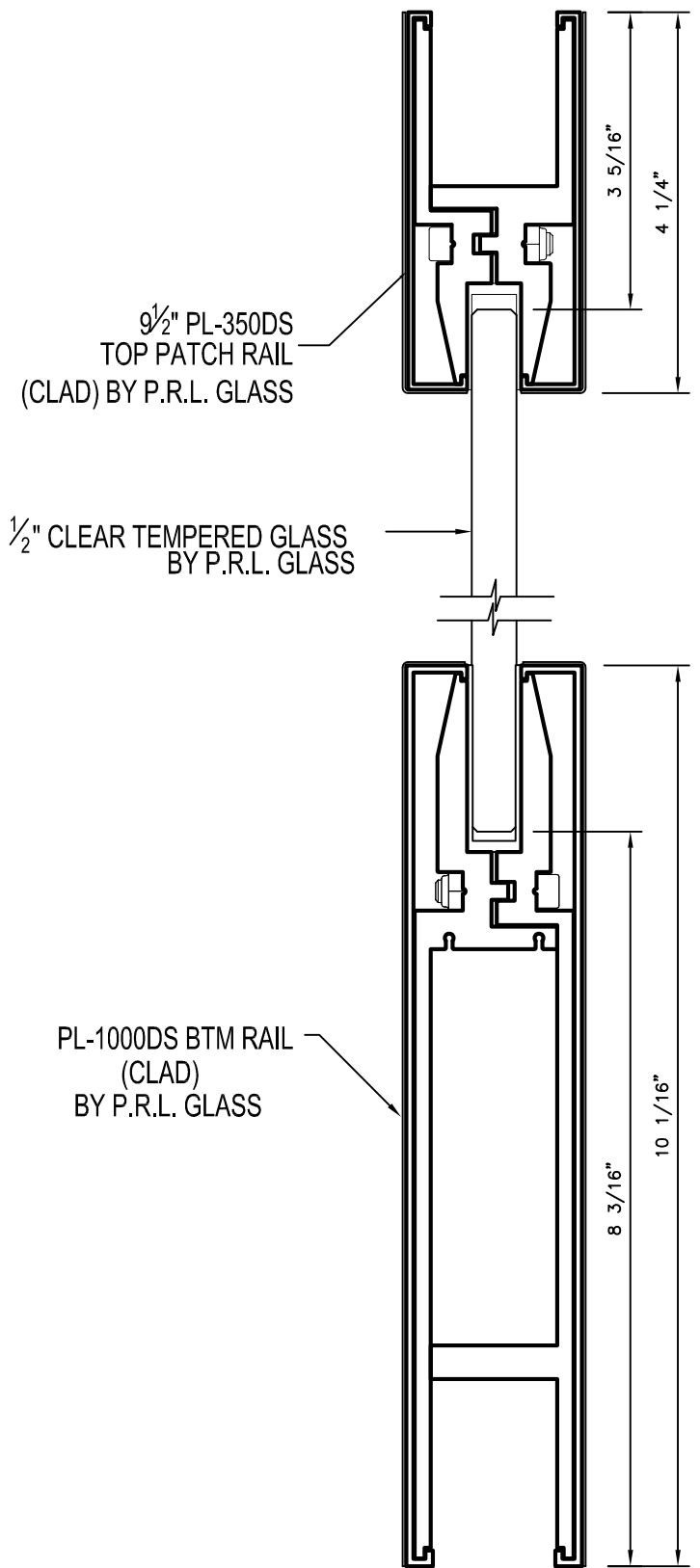
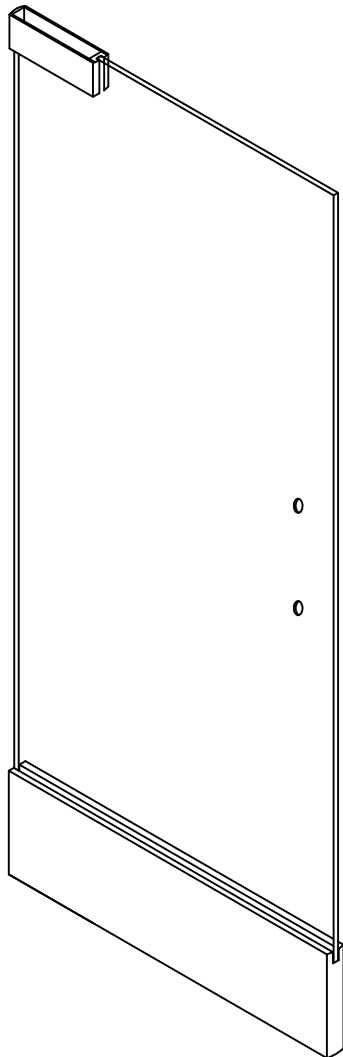

# BP-STYLE DOOR

9 1/2" PL350DS TOP  
PL600DS BOTTOM

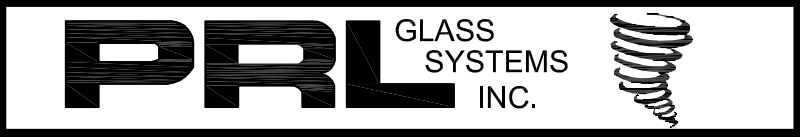

\* FINISHES AVAILABLE :  
# 8 POLISHED & # 4 SATIN  
STAINLESS  
US3 POLISHED & US4 SATIN  
BRASS ( NON LACQUER COATED )  
US10B  
ANODIZED PAINTED

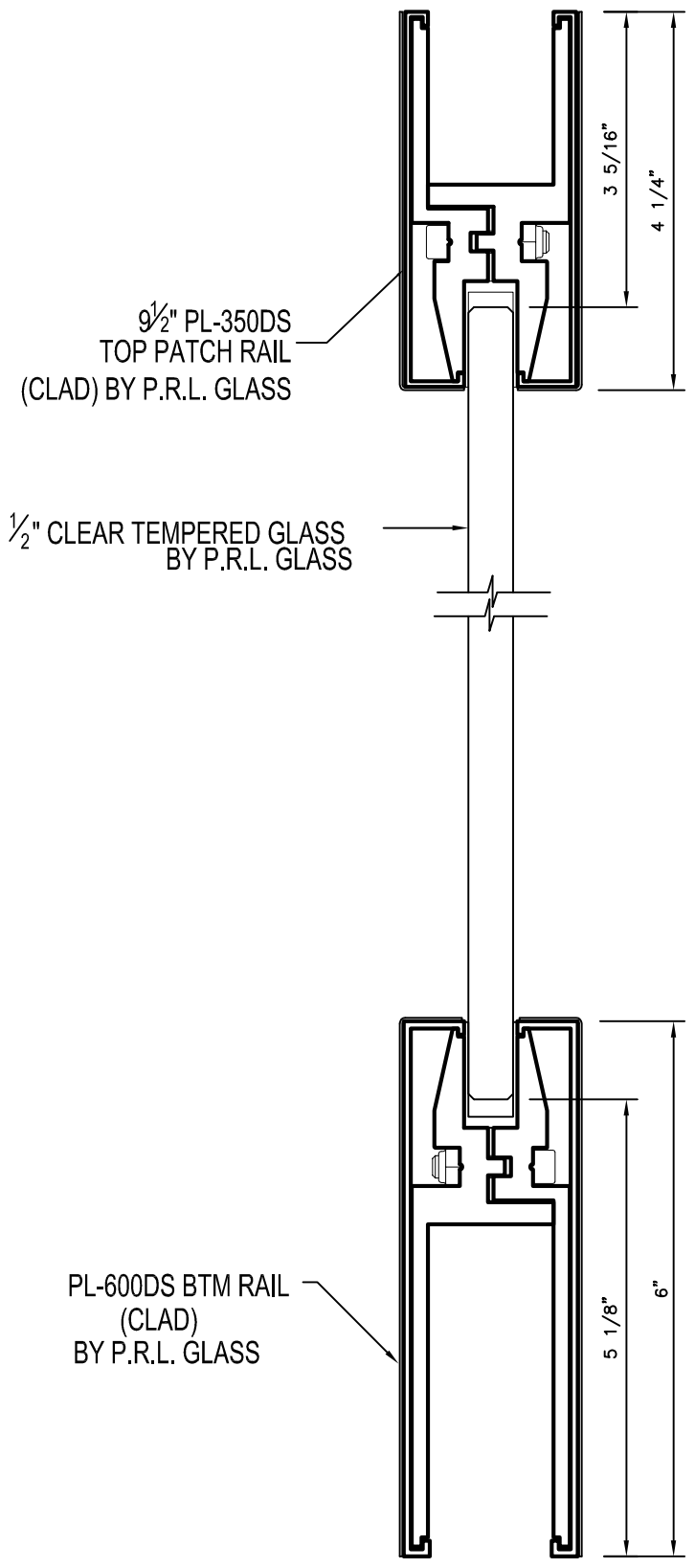
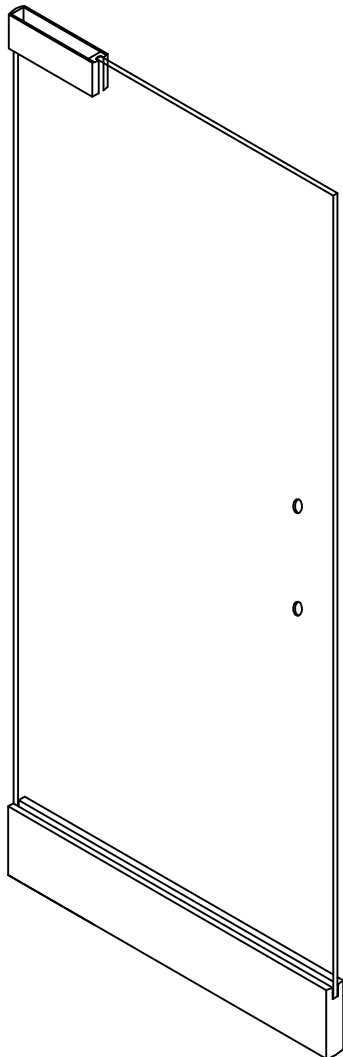

# BP-STYLE DOOR

9 1/2" PL375DS TOP  
PL1075DS BOTTOM

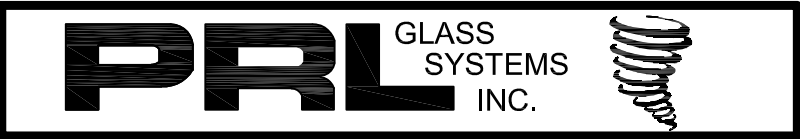

\* FINISHES AVAILABLE :  
# 8 POLISHED & # 4 SATIN  
STAINLESS  
US3 POLISHED & US4 SATIN  
BRASS ( NON LACQUER COATED )  
US10B  
ANODIZED PAINTED

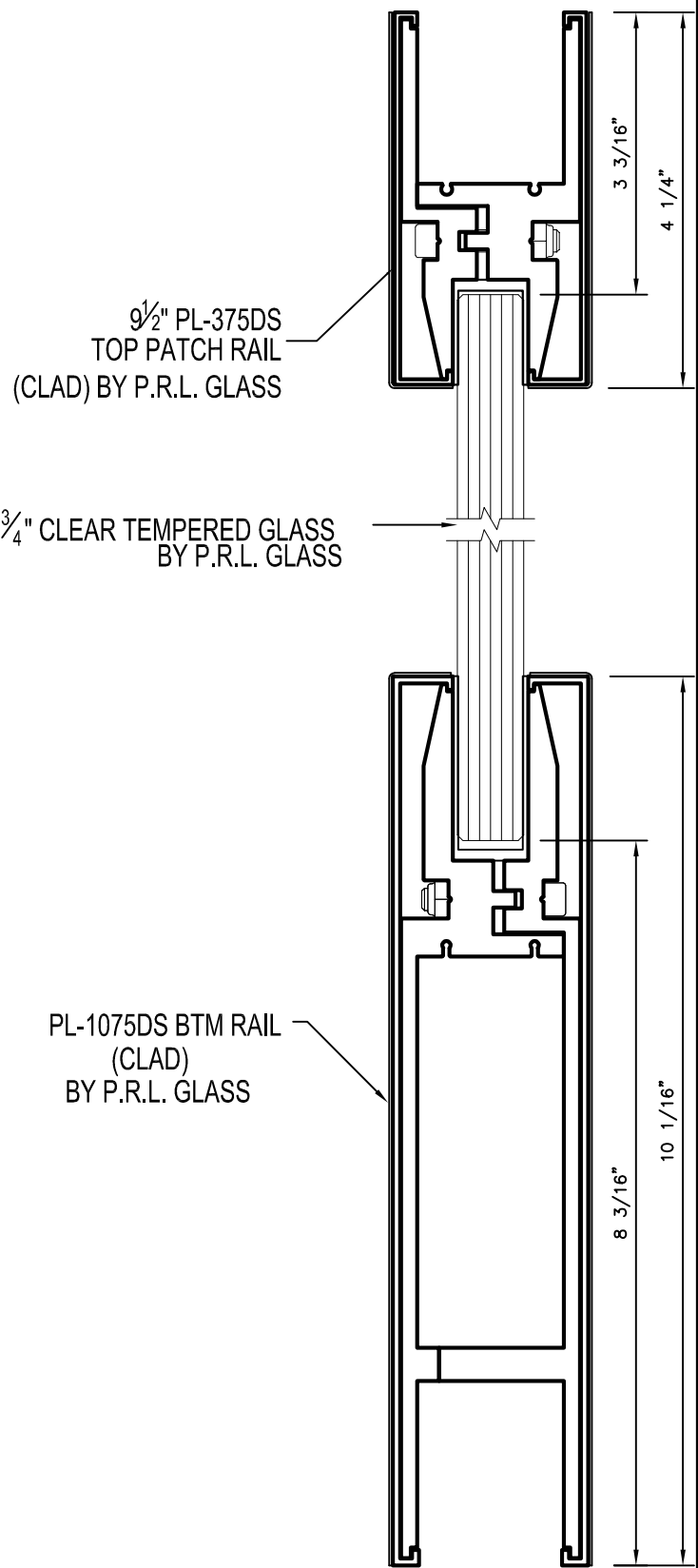
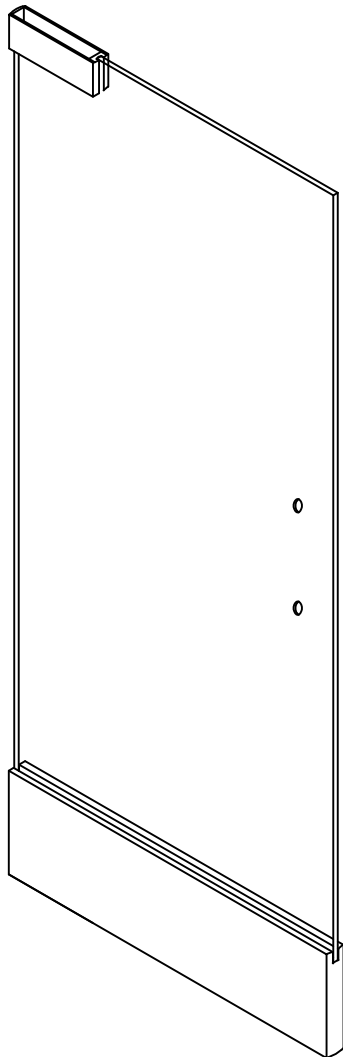

# BP-STYLE DOOR

9 1/2" PL375DS TOP  
PL1075DS BOTTOM

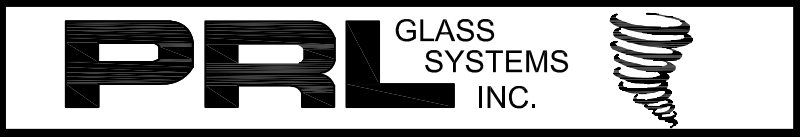

\* FINISHES AVAILABLE :  
# 8 POLISHED & # 4 SATIN  
STAINLESS  
US3 POLISHED & US4 SATIN  
BRASS ( NON LACQUER COATED )  
US10B  
ANODIZED PAINTED

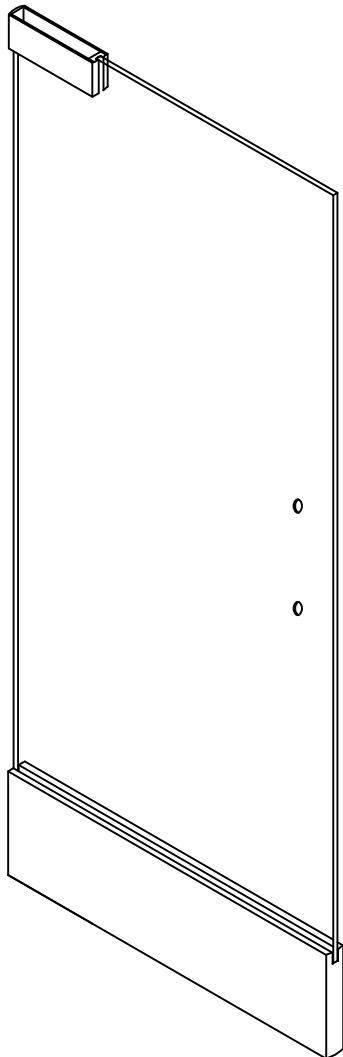

9 1/2" PL-375DS  
TOP PATCH RAIL  
(CLAD) BY P.R.L. GLASS

5/8" CLEAR TEMPERED GLASS  
BY P.R.L. GLASS

PL-1075DS BTM RAIL  
(CLAD)  
BY P.R.L. GLASS

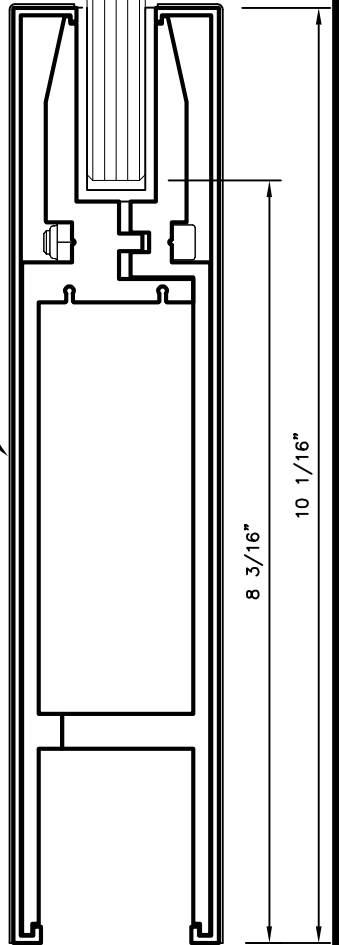
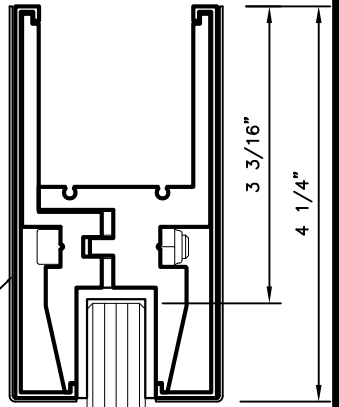



# BP-STYLE DOOR EURO TOP PATCH PL1000DS BOTTOM

**PRL** GLASS SYSTEMS INC.



\* FINISHES AVAILABLE :  
# 8 POLISHED & # 4 SATIN  
STAINLESS  
US3 POLISHED & US4 SATIN  
BRASS ( NON LACQUER COATED )  
US10B  
ANODIZED PAINTED

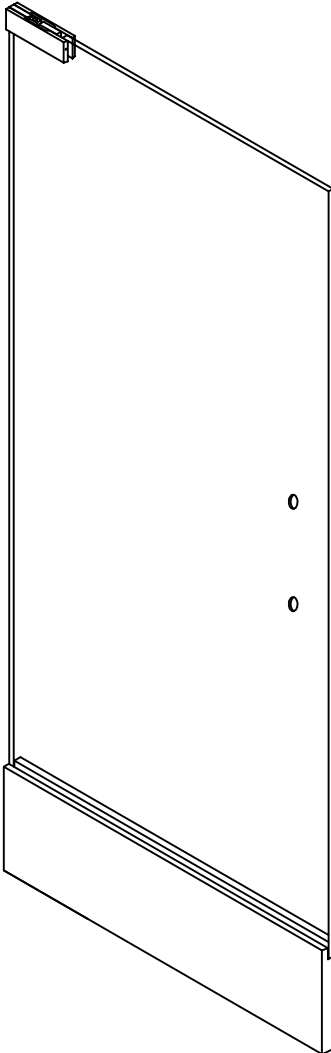

PL424 - 2 X 6<sup>1</sup>/<sub>2</sub>"  
EURO TOP PATCH  
(CLAD) BY P.R.L. GLASS

1/2" CLEAR TEMPERED GLASS  
BY P.R.L. GLASS

PL-1000DS BTM RAIL  
(CLAD)  
BY P.R.L. GLASS

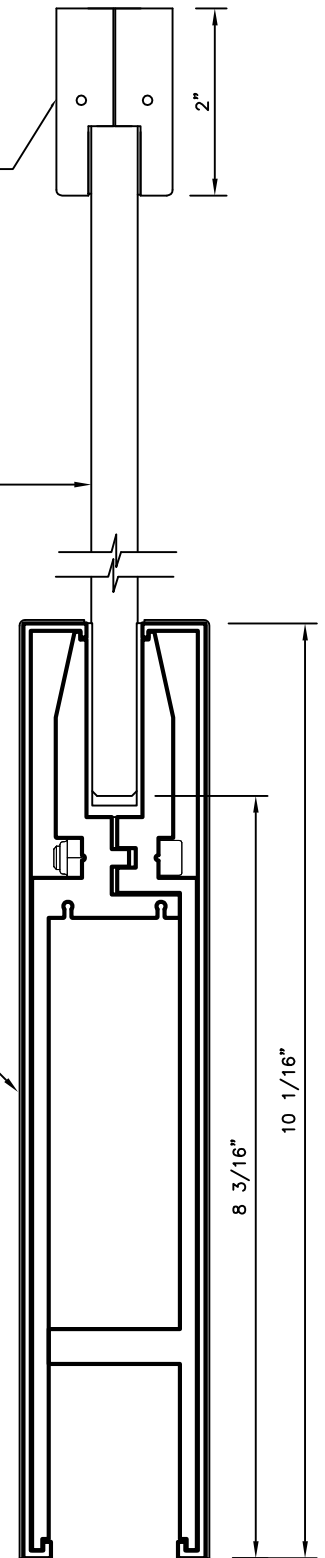

# BP-STYLE DOOR EURO TOP PATCH PL150DS BOTTOM

**PRL** GLASS SYSTEMS INC.



\* FINISHES AVAILABLE :  
# 8 POLISHED & # 4 SATIN  
STAINLESS  
US3 POLISHED & US4 SATIN  
BRASS ( NON LACQUER COATED )  
US10B  
ANODIZED PAINTED

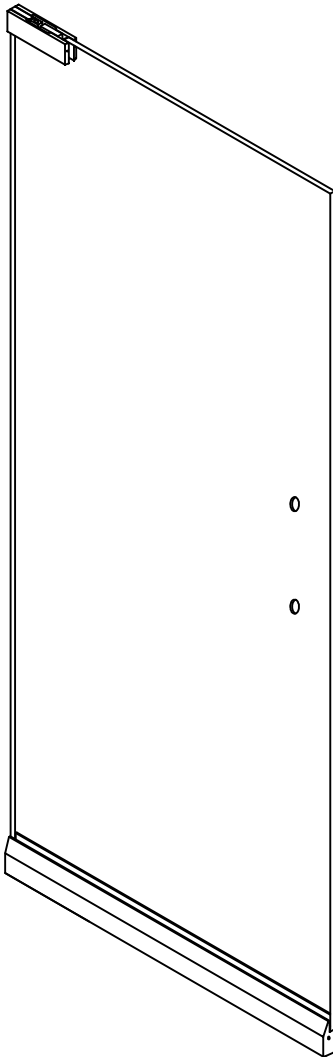

PL424 - 2 X 6 $\frac{1}{2}$ " EURO TOP PATCH  
(CLAD) BY P.R.L. GLASS

$\frac{1}{2}$ " CLEAR TEMPERED GLASS  
BY P.R.L. GLASS

PL-150DS  
BTM RAIL (CLAD)  
BY P.R.L. GLASS

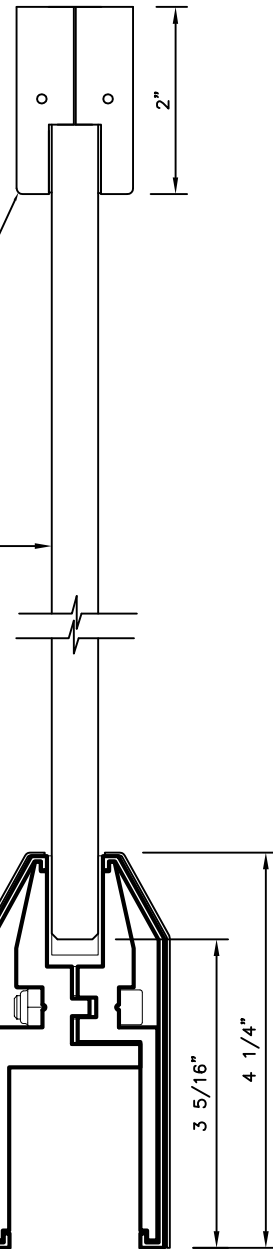

# BP-STYLE DOOR EURO TOP PATCH PL175DS BOTTOM

**PRL** GLASS SYSTEMS INC.



\* FINISHES AVAILABLE :  
# 8 POLISHED & # 4 SATIN  
STAINLESS  
US3 POLISHED & US4 SATIN  
BRASS ( NON LACQUER COATED)  
US10B  
ANODIZED PAINTED

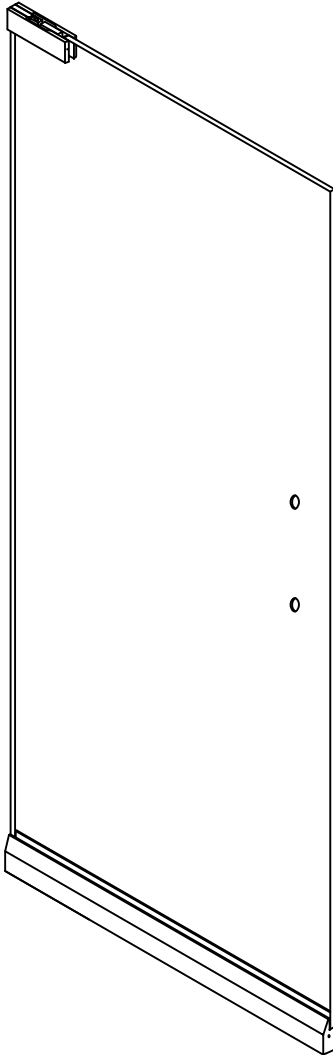

PL420 - 2 X 6 $\frac{1}{2}$ " EURO TOP PATCH  
(CLAD) BY P.R.L. GLASS

$\frac{3}{4}$ " CLEAR TEMPERED GLASS  
BY P.R.L. GLASS

PL-175DS  
BTM RAIL (CLAD)  
BY P.R.L. GLASS

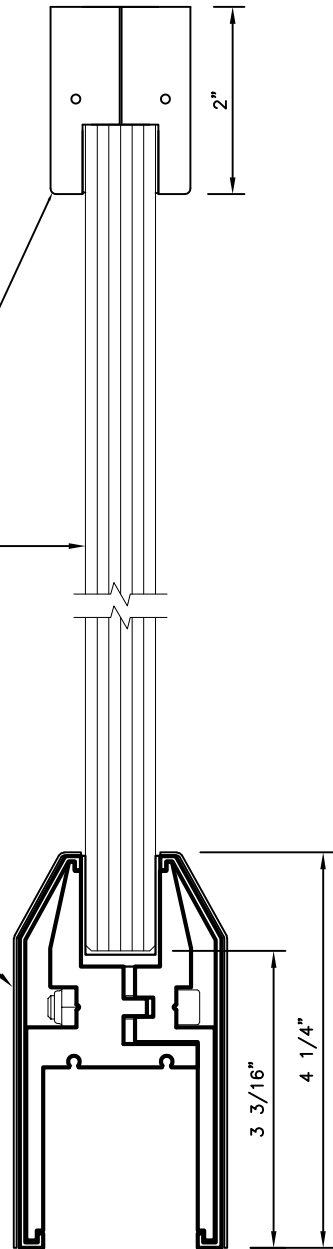

# BP-STYLE DOOR EURO TOP PATCH PL175DS BOTTOM

**PRL** GLASS SYSTEMS INC.



\* FINISHES AVAILABLE :  
# 8 POLISHED & # 4 SATIN  
STAINLESS  
US3 POLISHED & US4 SATIN  
BRASS ( NON LACQUER COATED )  
US10B  
ANODIZED PAINTED

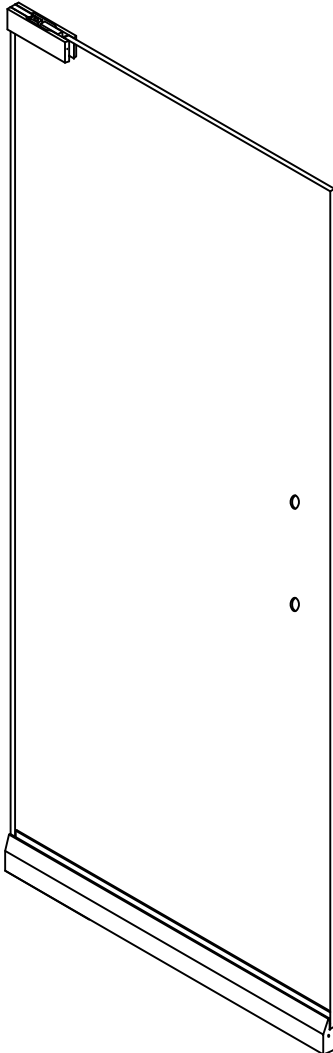

PL420 - 2 X 6 1/2" EURO TOP PATCH  
(CLAD) BY P.R.L. GLASS

5/8" CLEAR TEMPERED GLASS  
BY P.R.L. GLASS

PL-175DS  
BTM RAIL (CLAD)  
BY P.R.L. GLASS

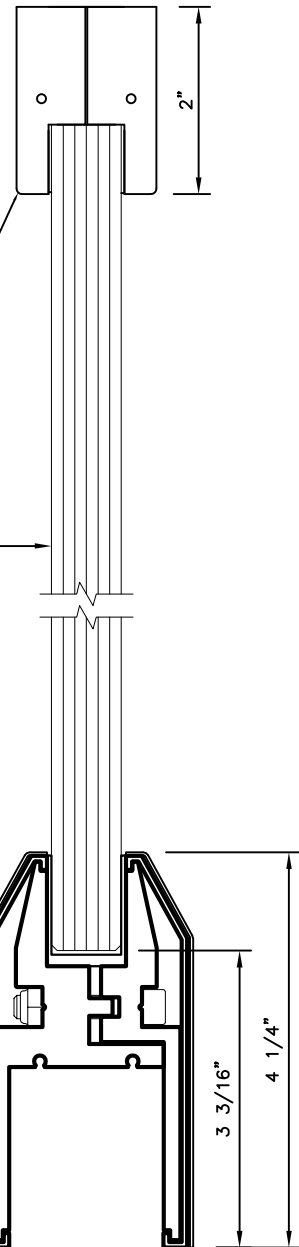

# BP-STYLE DOOR EURO TOP PATCH PL350DS BOTTOM

**PRL** GLASS SYSTEMS INC.



\* FINISHES AVAILABLE :  
# 8 POLISHED & # 4 SATIN  
STAINLESS  
US3 POLISHED & US4 SATIN  
BRASS ( NON LACQUER COATED)  
US10B  
ANODIZED PAINTED

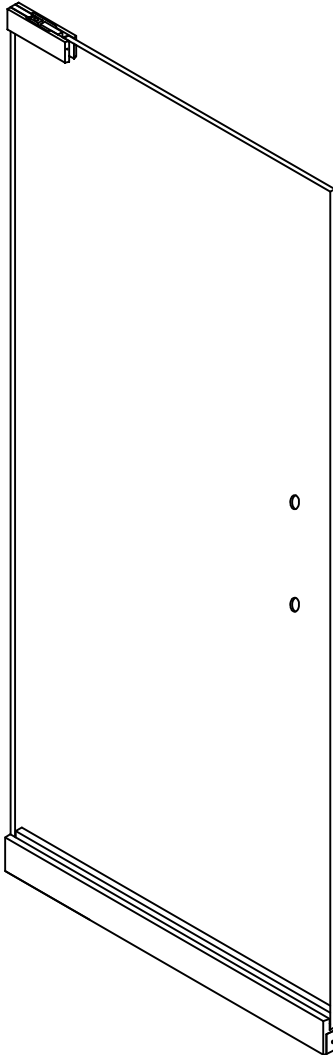

PL424 - 2 X 6 $\frac{1}{2}$ " EURO TOP PATCH  
(CLAD) BY P.R.L. GLASS

$\frac{1}{2}$ " CLEAR TEMPERED GLASS  
BY P.R.L. GLASS

PL-350DS BTM RAIL  
(CLAD)  
BY P.R.L. GLASS

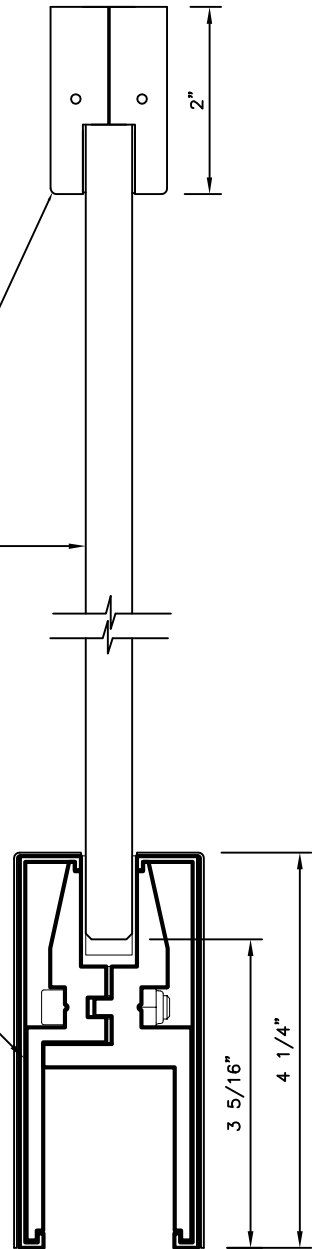

# BP-STYLE DOOR EURO TOP PATCH PL375DS BOTTOM

**PRL** GLASS SYSTEMS INC.



\* FINISHES AVAILABLE :  
# 8 POLISHED & # 4 SATIN  
STAINLESS  
US3 POLISHED & US4 SATIN  
BRASS ( NON LACQUER COATED)  
US10B  
ANODIZED PAINTED

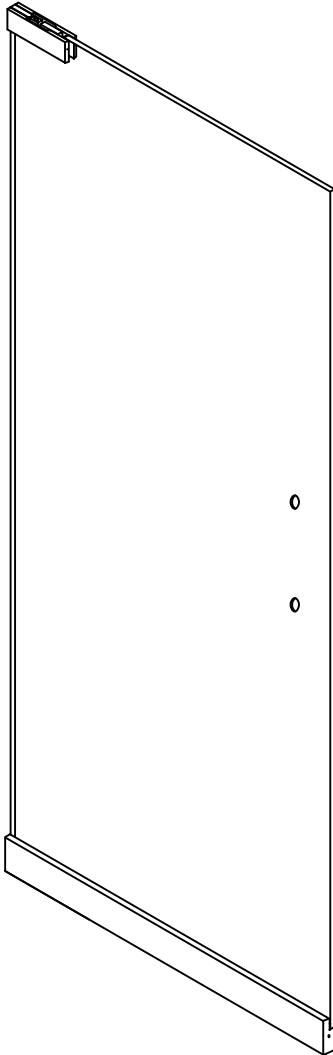

PL420 - 2 X 6 $\frac{1}{2}$ " EURO TOP PATCH  
(CLAD) BY P.R.L. GLASS

$\frac{3}{4}$ " CLEAR TEMPERED GLASS  
BY P.R.L. GLASS

PL-375DS  
BTM RAIL (CLAD)  
BY P.R.L. GLASS

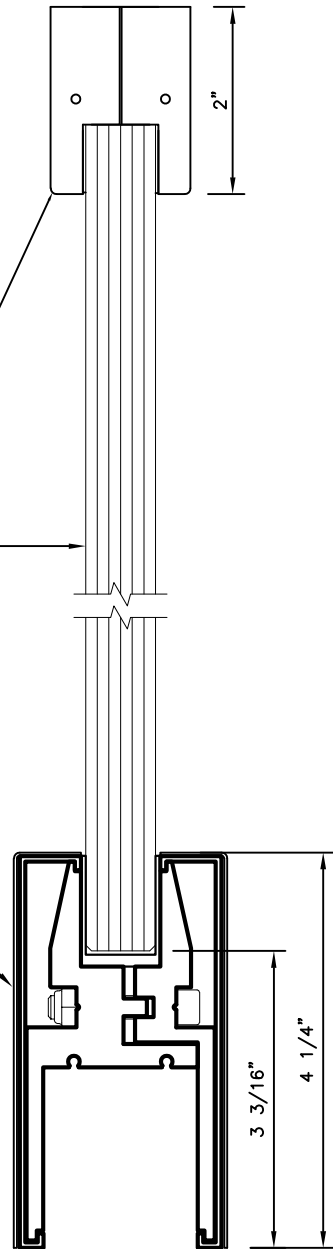

# BP-STYLE DOOR EURO TOP PATCH PL600DS BOTTOM

**PRL** GLASS SYSTEMS INC.



\* FINISHES AVAILABLE :  
# 8 POLISHED & # 4 SATIN  
STAINLESS  
US3 POLISHED & US4 SATIN  
BRASS ( NON LACQUER COATED )  
US10B  
ANODIZED PAINTED

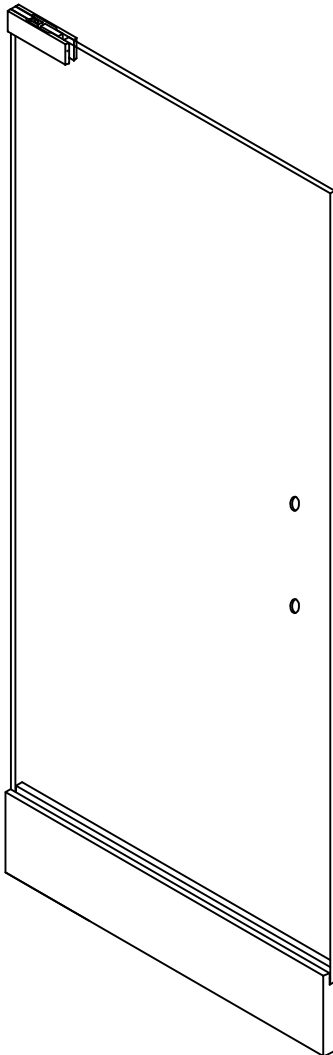

PL424 - 2 X 6 $\frac{1}{2}$ "  
EURO TOP PATCH  
(CLAD) BY P.R.L. GLASS

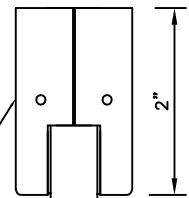

$\frac{1}{2}$ " CLEAR TEMPERED GLASS  
BY P.R.L. GLASS

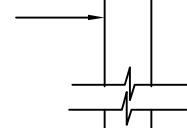

PL-600DS BTM RAIL  
(CLAD)  
BY P.R.L. GLASS

