

450 SERIES
1 3/4" x 4 1/2"
SECTION

**ALUMINUM STOREFRONTS
PL-450 SERIES**

PART 1 GENERAL

1.1 SECTION INCLUDES

- A. Aluminum storefronts.

1.2 REFERENCES

- A. ASTM International (ASTM):
 1. ASTM B 221 - Standard Specification for Aluminum and Aluminum-Alloy Extruded Bars, Rods, Wire, Profiles, and Tubes.
 2. ASTM E 283 - Test Method for Determining the Rate of Air Leakage Through Exterior Windows, Curtain Walls, and Doors under Specified Pressure Differences across the Specimen.
 3. ASTM E 330 - Standard Test Method for Structural Performance of Exterior Windows, Doors, Skylights and Curtain Walls by Uniform Static Air Pressure Difference.
 4. ASTM E 331 - Test Method for Water Penetration of Exterior Windows, Curtain Walls, and Doors by Uniform Static Air Pressure Difference.

1.3 SUBMITTALS

- A. Submit under provisions of applicable Requirements.
- B. Product Data: Manufacturer's data sheets on each product to be used, including:
 1. Preparation instructions and recommendations.
 2. Storage and handling requirements and recommendations.
 3. Installation methods.
- C. Shop Drawings: Configuration and details for installation, maintenance and operation.
- D. Selection Samples: For each finish product specified, two complete sets of color chips representing manufacturer's full range of available colors and patterns.
- E. Verification Samples: For each finish product specified, two samples, minimum size 6 inches (150 mm) square representing actual product, color, and patterns.

1.4 QUALITY ASSURANCE

- A. Manufacturer Qualifications: Minimum 5 year experience manufacturing similar products.
- B. Installer Qualifications: Minimum 2 year experience installing similar products.
- C. Mock-Up: Provide a mock-up for evaluation of surface preparation techniques and application workmanship.
 1. Finish areas designated by Architect.
 2. Do not proceed with remaining work until workmanship is approved by Architect.
 3. Refinish mock-up area as required to produce acceptable work.

1.5 PRE-INSTALLATION MEETINGS

PL-450 - 1

- A. Convene minimum two weeks prior to starting work of this section.

1.6 DELIVERY, STORAGE, AND HANDLING

- A. Deliver and store products in manufacturer's unopened packaging bearing the brand name and manufacturer's identification until ready for installation.
- B. Handling: Handle materials to avoid damage.

1.7 PROJECT CONDITIONS

- A. Maintain environmental conditions (temperature, humidity, and ventilation) within limits recommended by manufacturer for optimum results. Do not install products under environmental conditions outside manufacturer's recommended limits.

1.8 SEQUENCING

- A. Ensure that products of this section are supplied to affected trades in time to prevent interruption of construction progress.

PART 2 PRODUCTS

2.1 MANUFACTURERS

- A. Acceptable Manufacturer: PRL Glass Systems, Inc., which is located at: 13644 Nelson Ave.; City of Industry, CA 91746; Toll Free Tel: 800-433-7044; Fax: 626-968-9256; Email: request; Web:prlglass.com
- B. Substitutions: Not permitted.
- C. Requests for substitutions will be considered in accordance with provisions of Section 01 60 00 - Product Requirements.

2.2 ALUMINUM STOREFRONT

- A. Product: Aluminum Storefront Series as manufactured by PRL Glass Systems, Inc.
- B. Design:
 - 1. Framing sections shall be extruded from 6063-T5 aluminum alloy.
 - 2. Glazing beads shall be NS (non-stretch, high-shore) vinyl used on both sides of the glass. Vinyl shall incorporate a fiberglass cord bonded with the vinyl.
 - 3. Sections shall conform to details and shall present clean, straight, sharply defined lines, and shall be free from defects impairing strength or durability.
 - 4. Screws, nuts, bolts and fastening devices and internal components shall be of aluminum, stainless steel or other non-corrosive material.
 - 5. Factory preparation from detail drawings shall be so fabricated that field assembly will be able to produce accurate, tightly fitted joints.
- C. **450-Series (1-3/4 X 4-1/2 Center Glaze for 1/4 Glazing):**
 - 1. Performance: (Test sample of 10 feet (3048 mm) wide by 10 feet (3048 mm) high - 3 lites wide by 2 lites high).
 - a. Air infiltration: Limit air leakage through fixed glazing and frames to 0.042 cfm/ft²/min when tested in accordance with ASTM E-283 at a cross pressure of 6.24 psf (0.30 kPa).
 - b. Water Penetration under Static Pressure: System shall not evidence uncontrolled water penetration at a cross pressure of 6 psf (0.29 kPa) when tested in accordance with ASTM-E331-00.
 - c. Uniform Load Structural per ASTM E 330: Limit deflection to L/175.

- 1) Passed at Design Pressure of 20 psf (0.96 kPa).

PART 3 EXECUTION

3.1 EXAMINATION

- A. Do not begin installation until substrates have been properly prepared.
- B. If substrate preparation is the responsibility of another installer, notify Architect of unsatisfactory preparation before proceeding.

3.2 PREPARATION

- A. Clean surfaces thoroughly prior to installation.
- B. Prepare surfaces using the methods recommended by the manufacturer for achieving the best result for the substrate under the project conditions.

3.3 INSTALLATION

- A. Install in accordance with manufacturer's instructions.

3.4 FIELD QUALITY CONTROL

- A. All joints between metal and masonry shall be fully caulked and field tested to resist water leakage with provisions taken to drain infiltrated water.

3.5 PROTECTION

- A. Protect installed products until completion of project.
- B. Touch-up, repair or replace damaged products before Substantial Completion.

END OF SECTION

PL-450 SERIES
1-3/4 X 4-1/2
1/4" CENTER GLAZED

PL-450 SERIES
 STOREFRONT MATERIAL



SCREW RACE

QUICK SET

SCREW RACE

QUICK SET

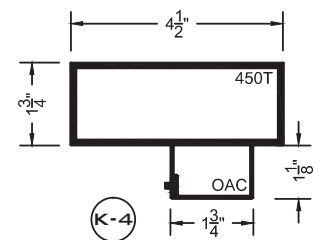
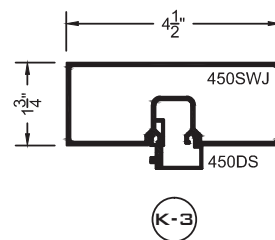
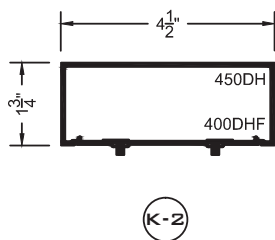
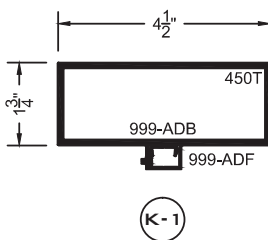
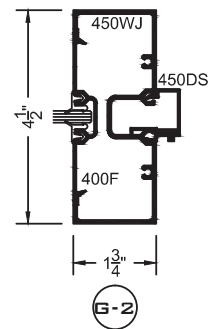
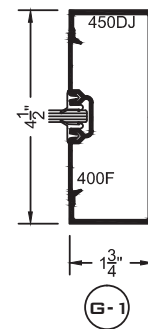
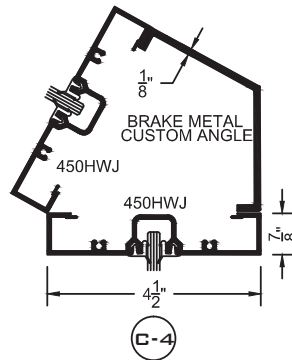
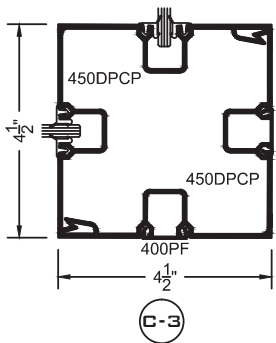
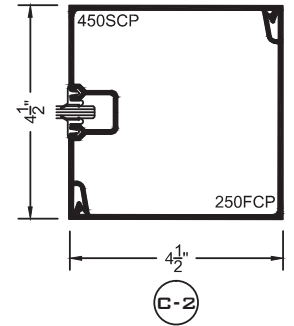
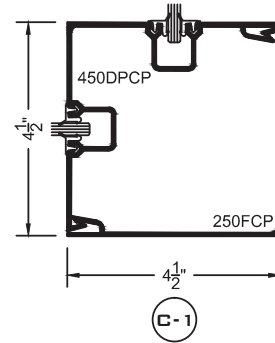
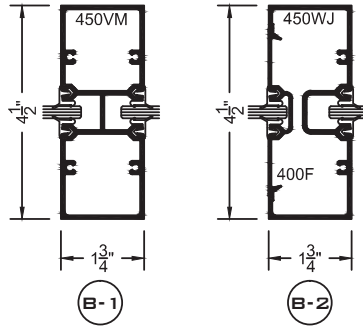
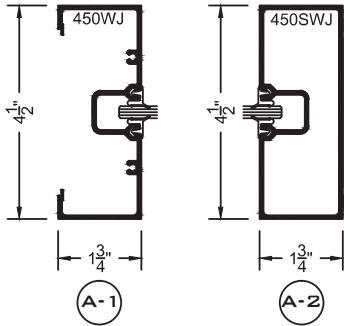
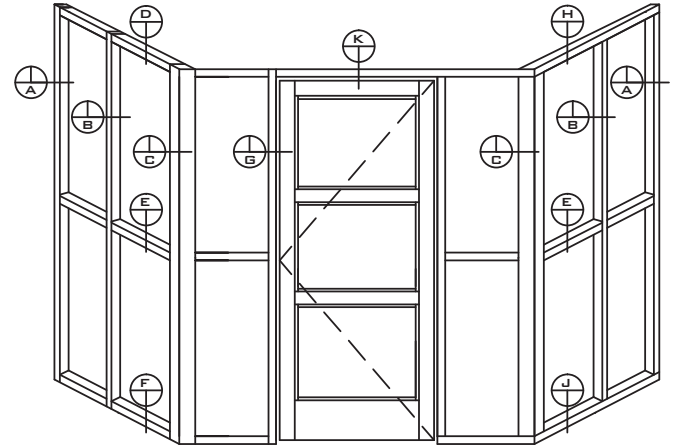
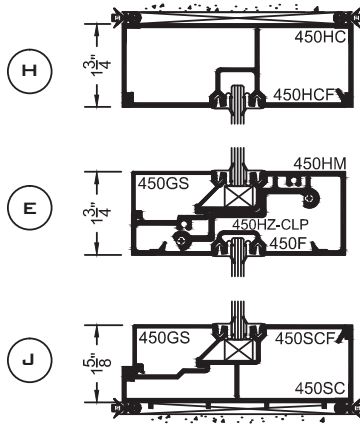
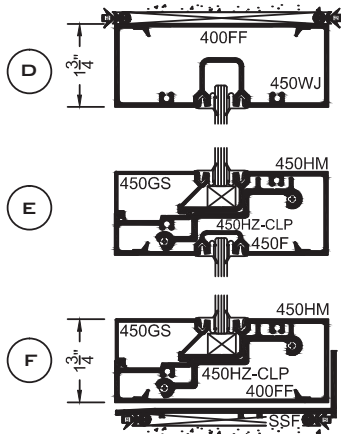

PL-450 - 4

ph: (877) 775-2586
 fx: (877) 274-8800

14760 Don Julian Rd.
 Industry, CA 91746

www.prlaluminum.com
 sales@prlaluminum.com

PL-450 SERIES
1-3/4 X 4-1/2
FULL SCALE

QUICK SET



H

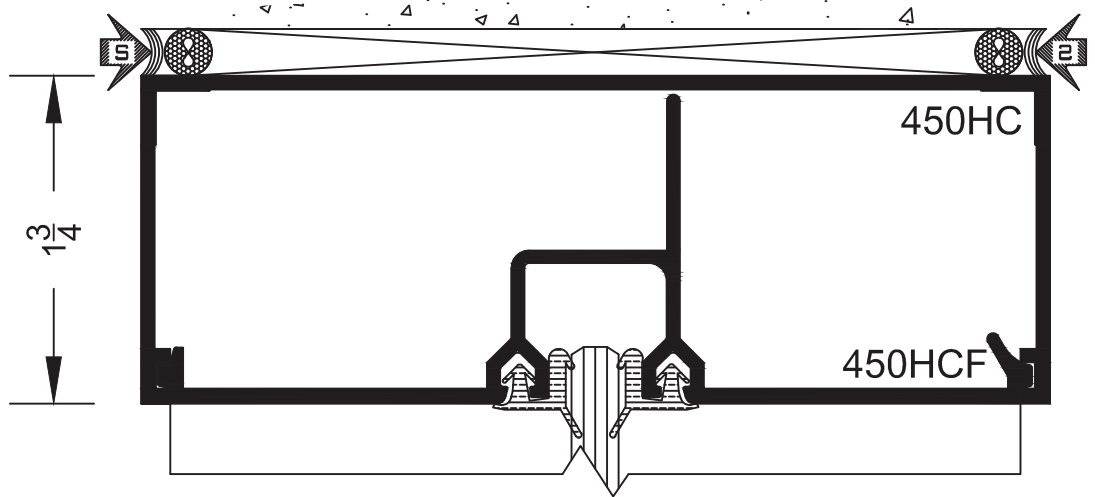

F

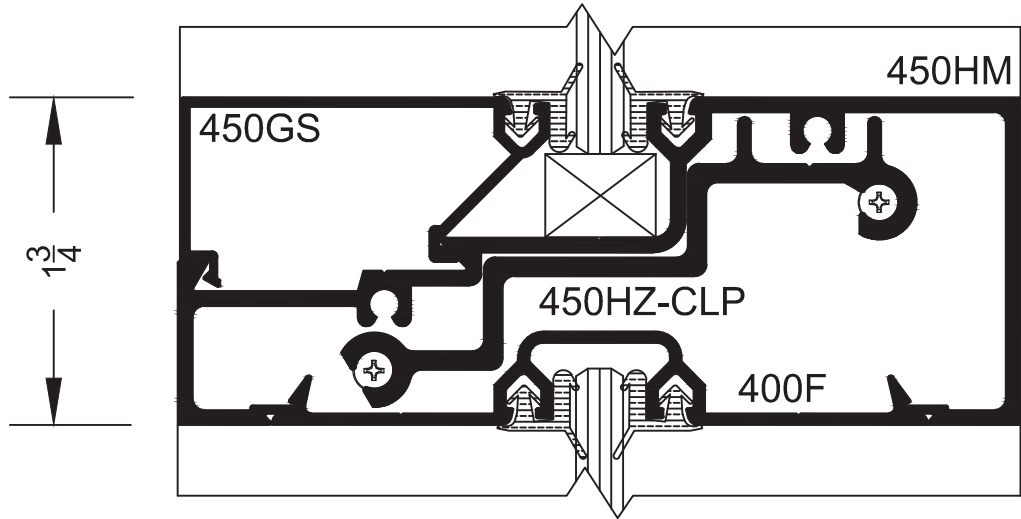

J

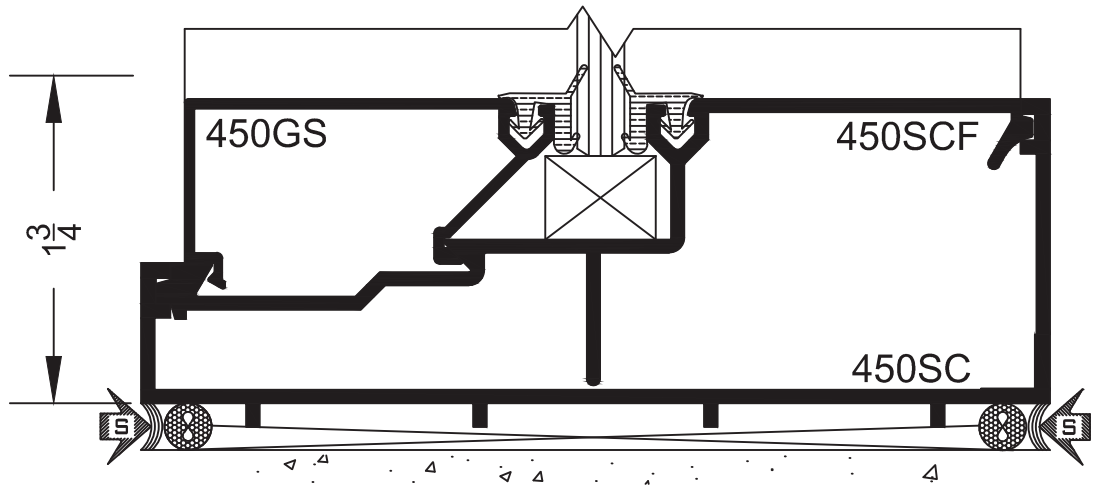

PL-450 - 5

ph: (877) 775-2586
 fx: (877) 274-8800

14760 Don Julian Rd.
 Industry, CA 91746

www.prlaluminum.com
sales@prlaluminum.com

PL-450 SERIES
1-3/4 X 4-1/2
FULL SCALE

SCREW RACE



D

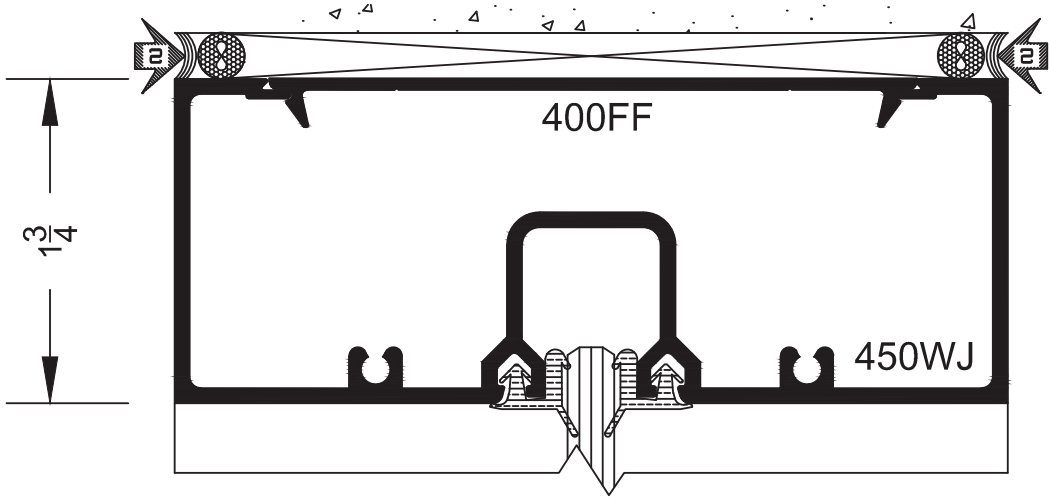

E

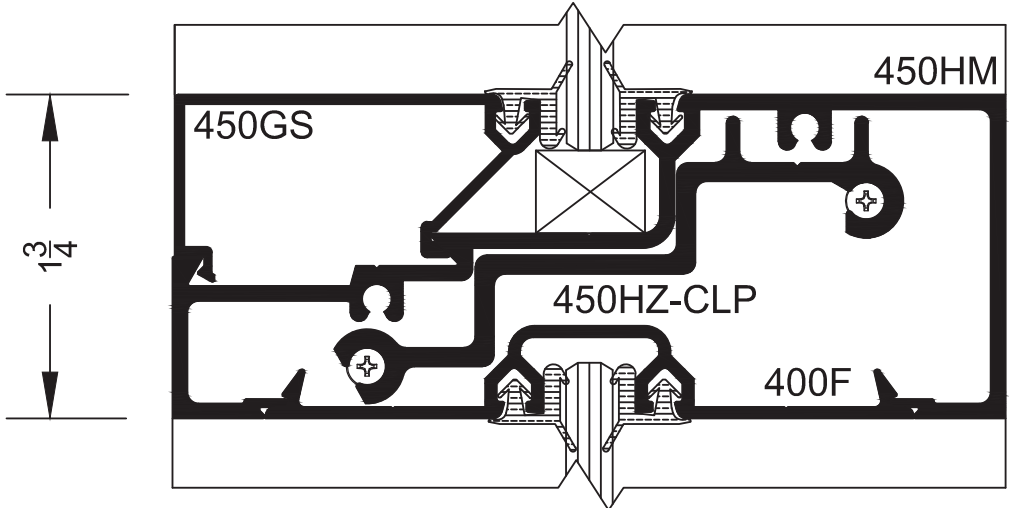

F

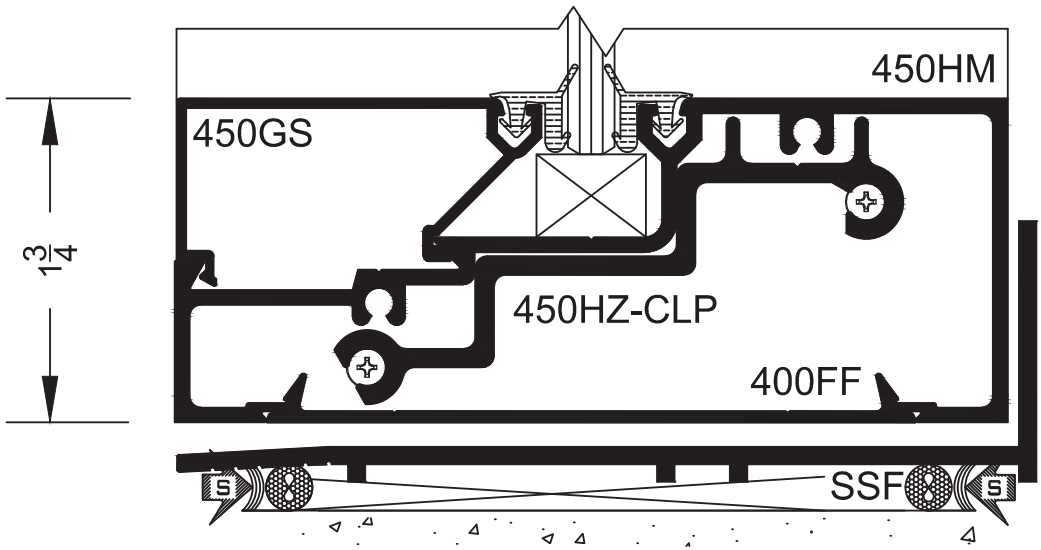

PL-450 - 6

ph: (877) 775-2586
 fx: (877) 274-8800

14760 Don Julian Rd.
 Industry, CA 91746

www.prlaluminum.com
 sales@prlaluminum.com

PL-450 SERIES
1-3/4 X 4-1/2
FULL SCALE

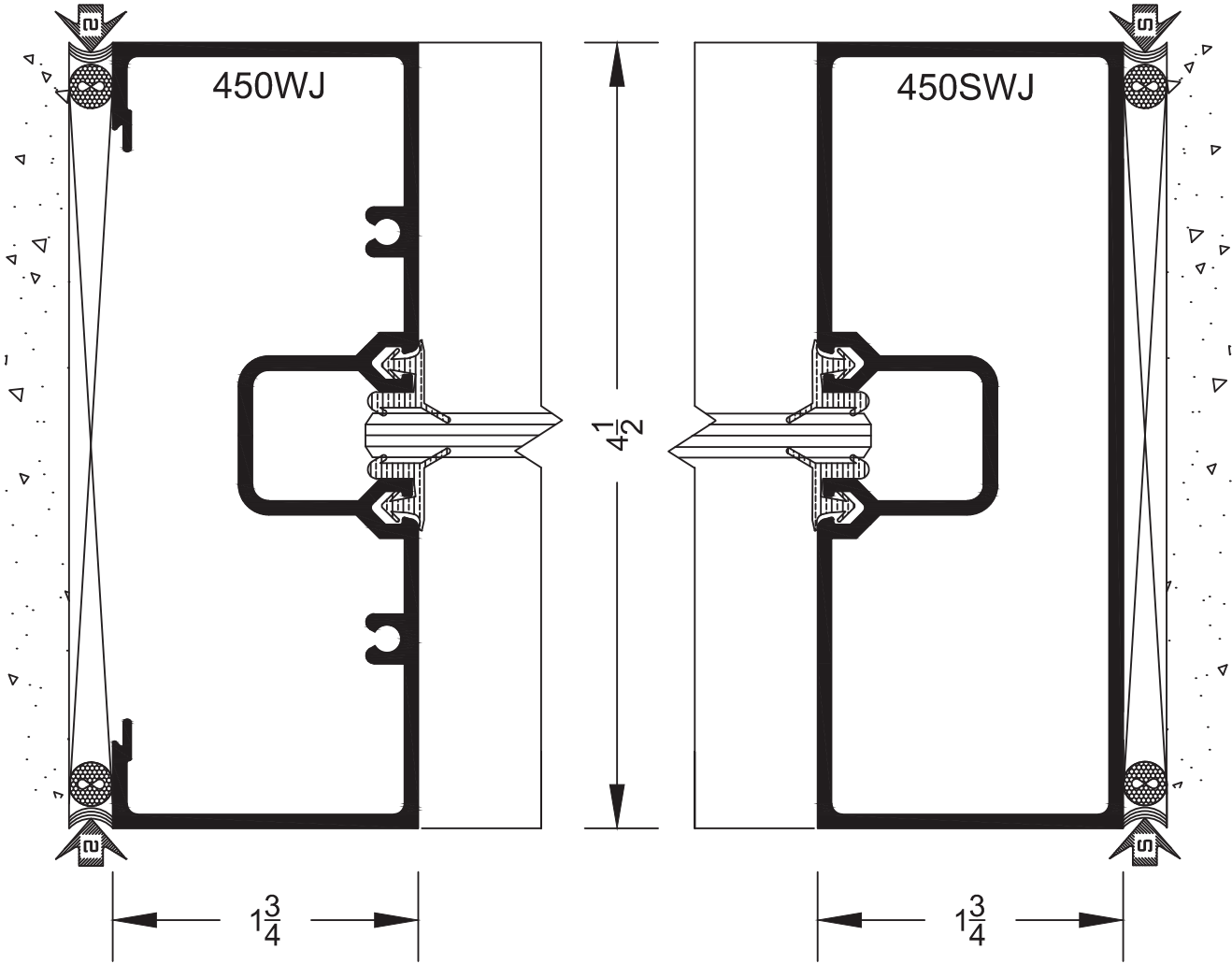

A-1

A-2

ph: (877) 775-2586
fx: (877) 274-8800

PL-450 - 7
14760 Don Julian Rd.
Industry, CA 91746

www.prlaluminum.com
sales@prlaluminum.com

PL-450 SERIES
1-3/4 X 4-1/2
FULL SCALE

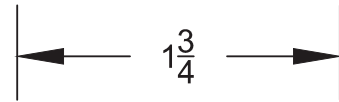
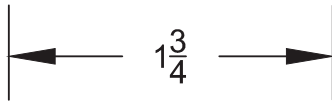
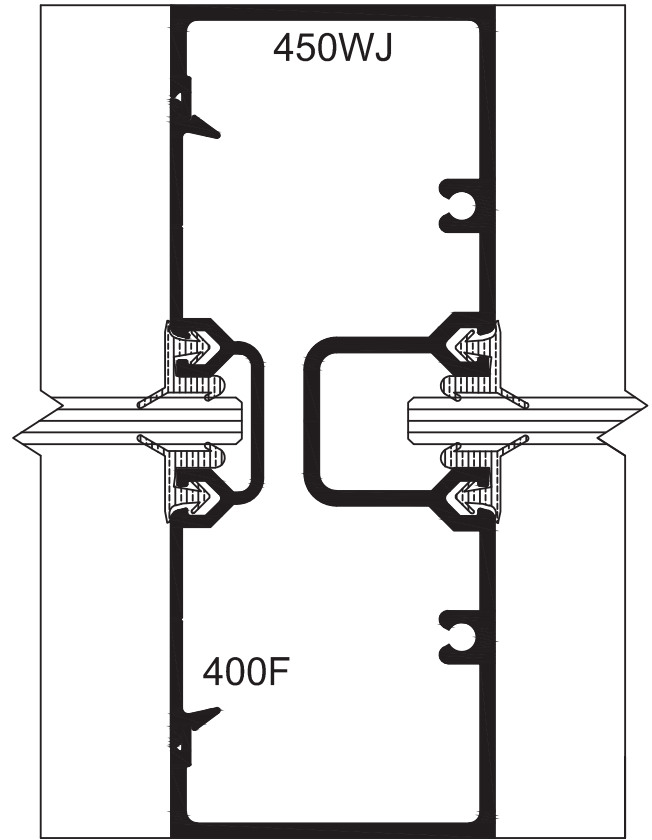
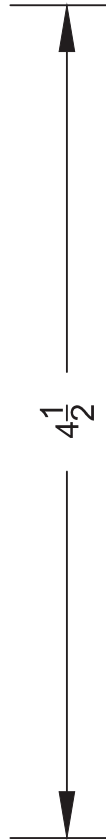
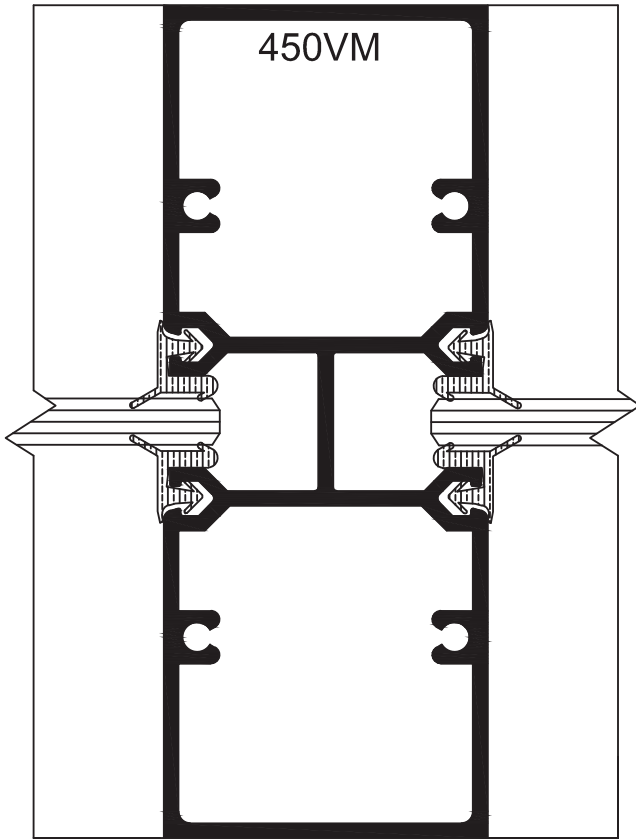

B-1

B-2

PL-450 SERIES
1-3/4 X 4-1/2
FULL SCALE

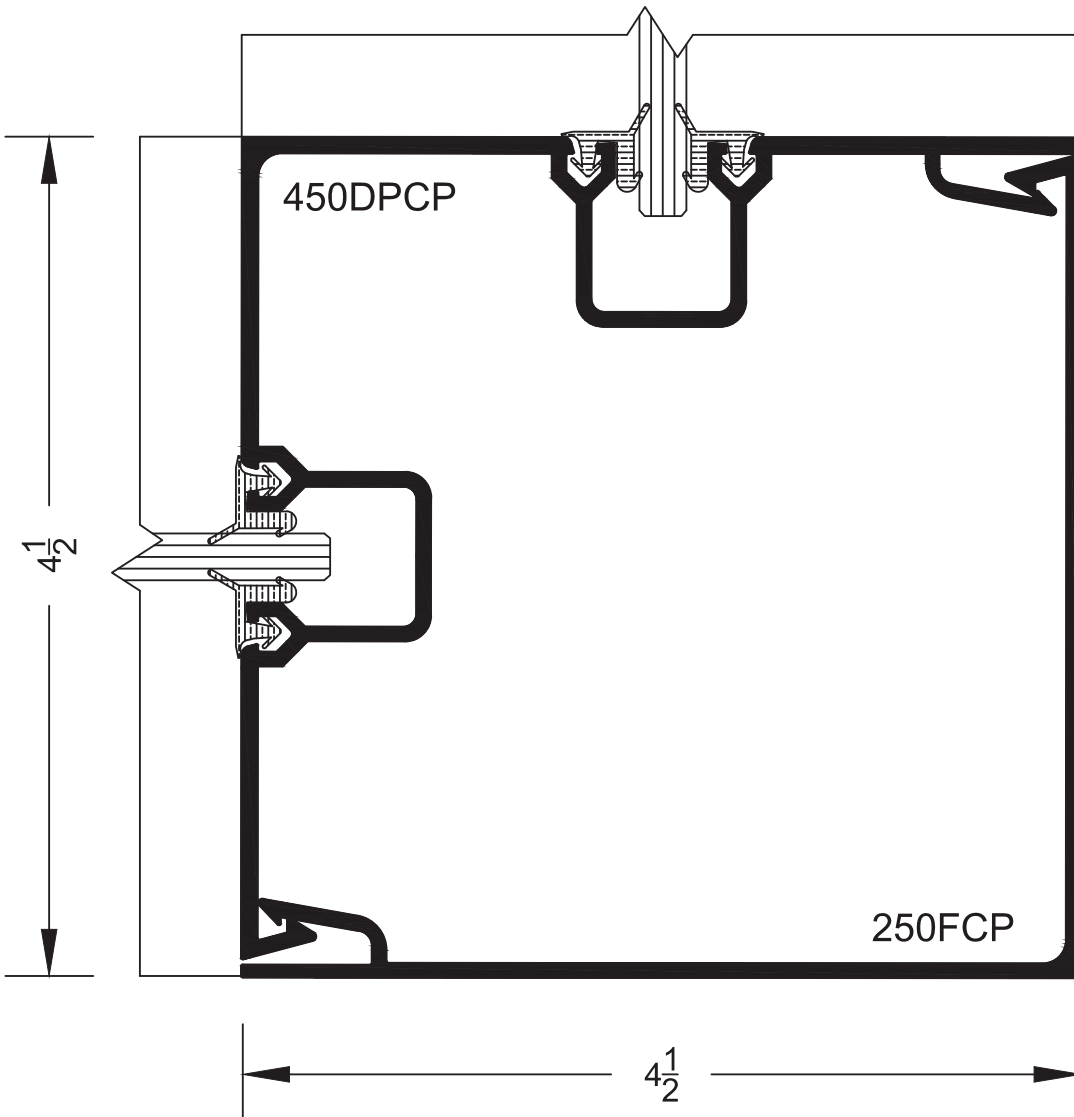

C-1

PL-450 SERIES
1-3/4 X 4-1/2
FULL SCALE

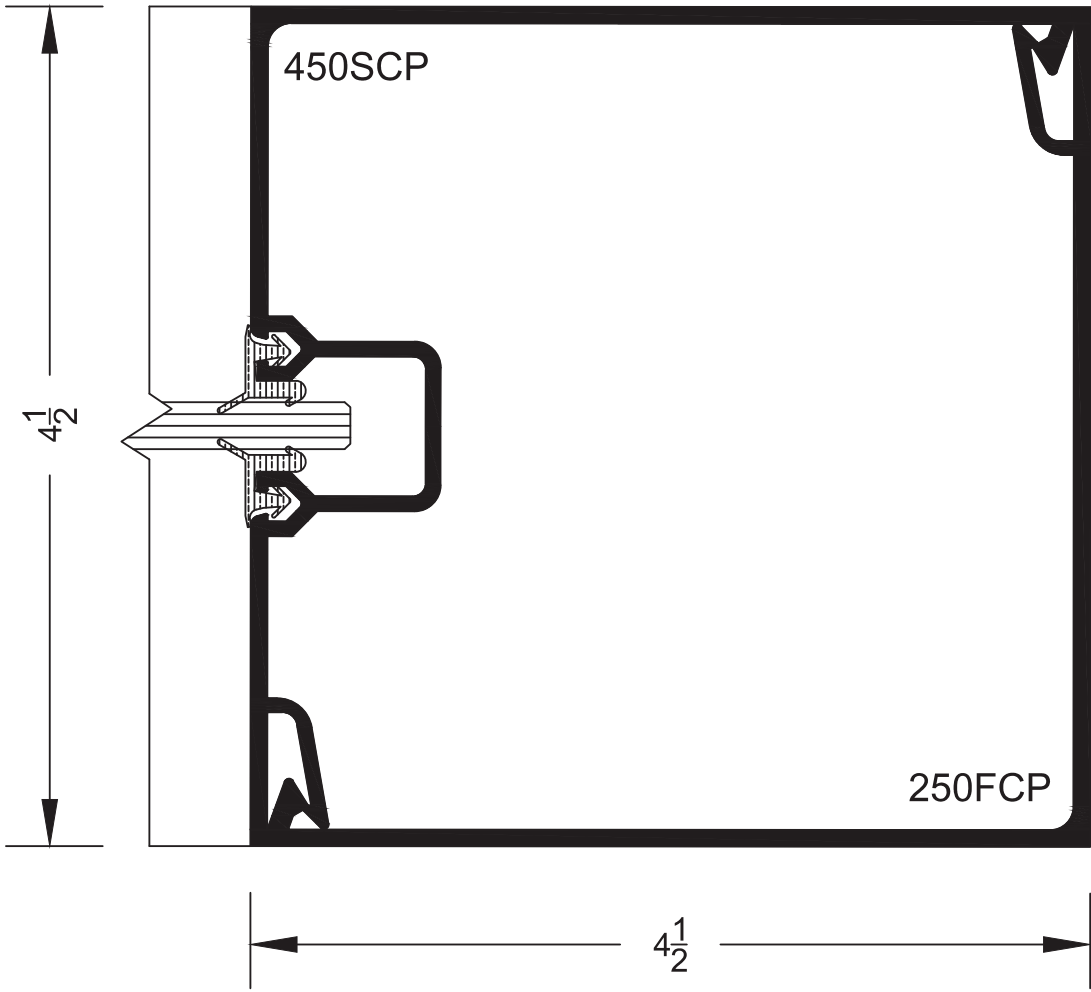

C-2

PL-450 SERIES
1-3/4 X 4-1/2
FULL SCALE

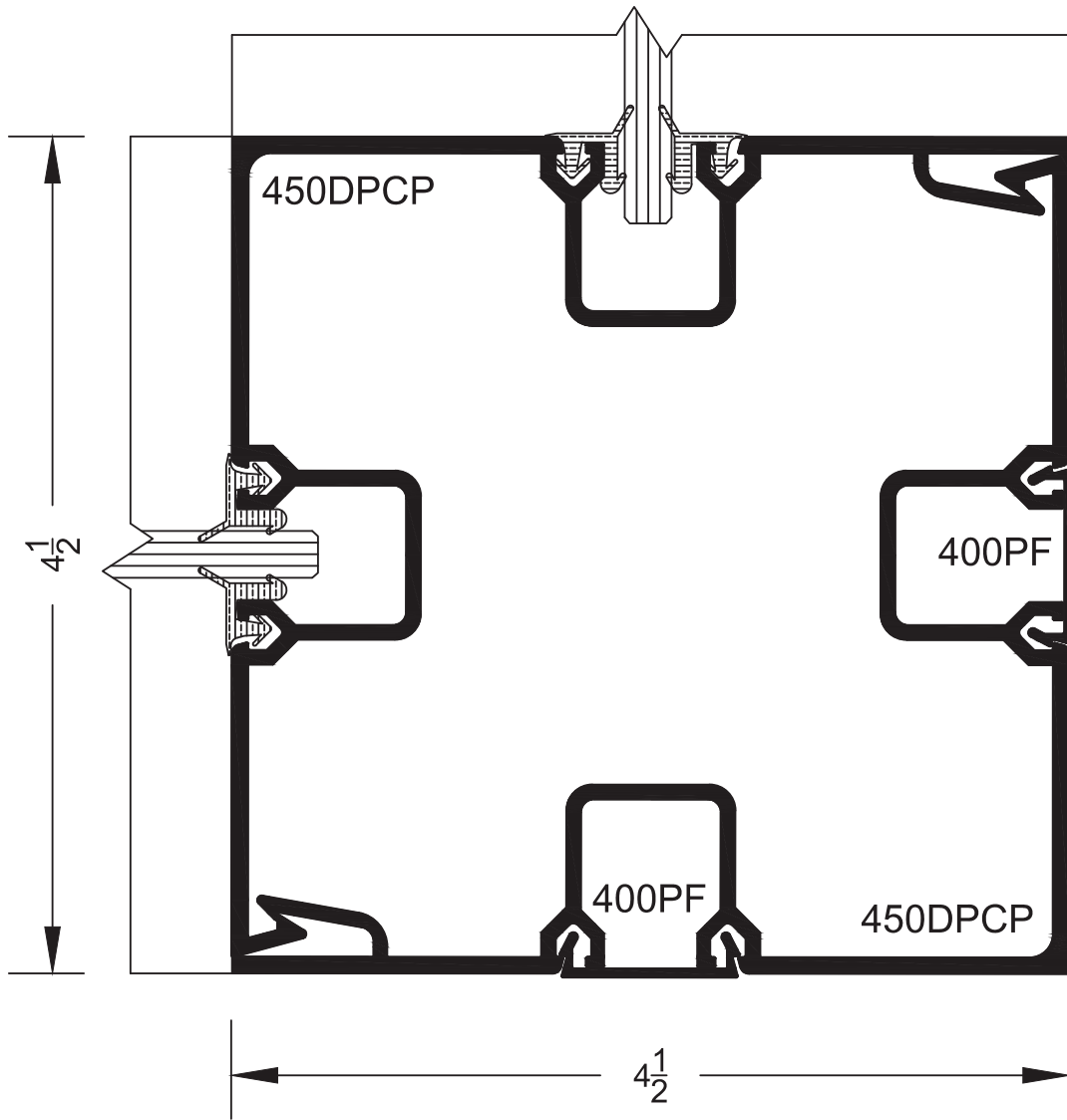

C-3

PL-450 SERIES
1-3/4 X 4-1/2
FULL SCALE

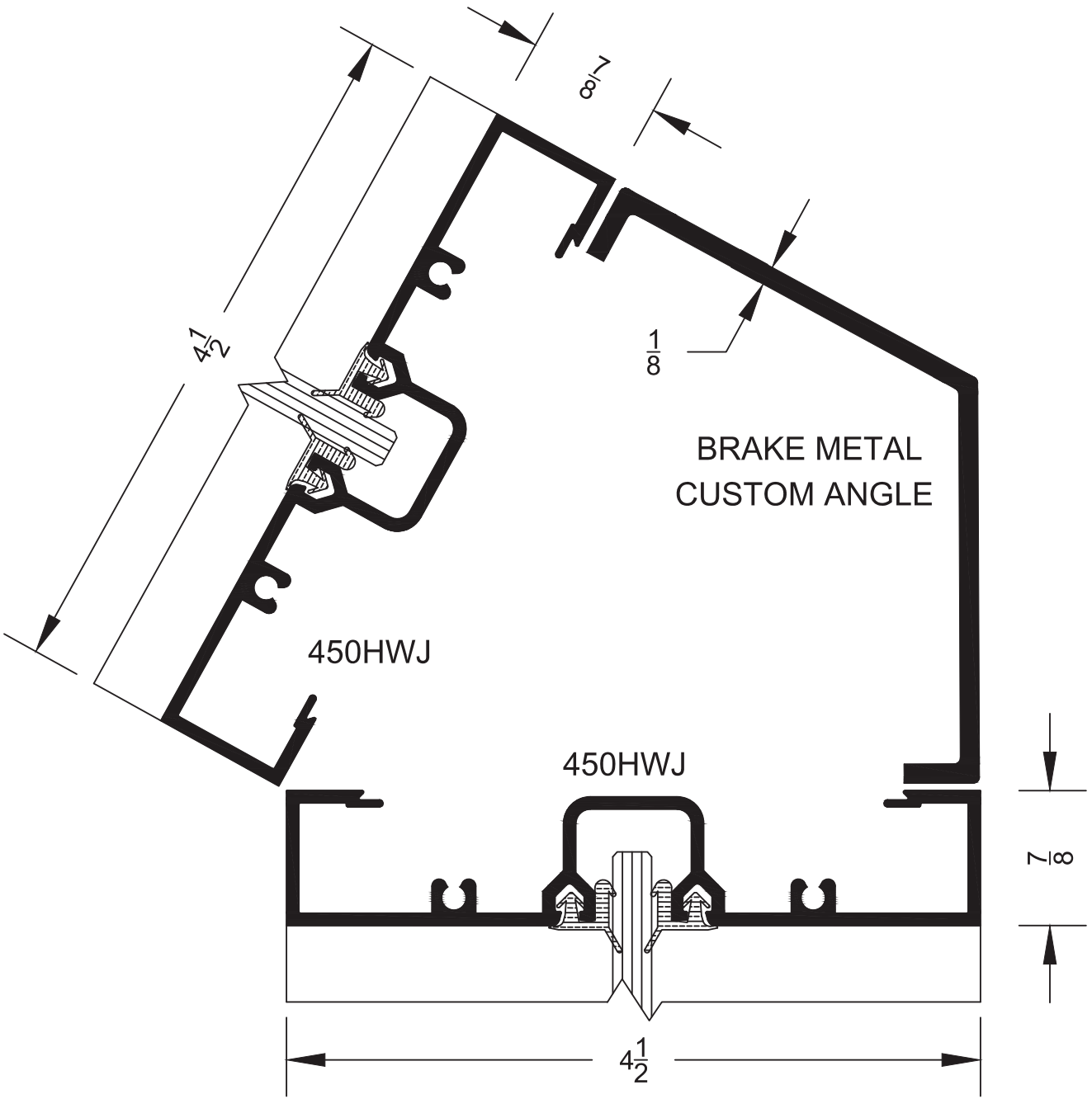

C-4

ph: (877) 775-2586
fx: (877) 274-8800

PL-450 - 12
14760 Don Julian Rd.
Industry, CA 91746

www.prlaluminum.com
sales@prlaluminum.com

PL-450 SERIES
1-3/4 X 4-1/2
FULL SCALE

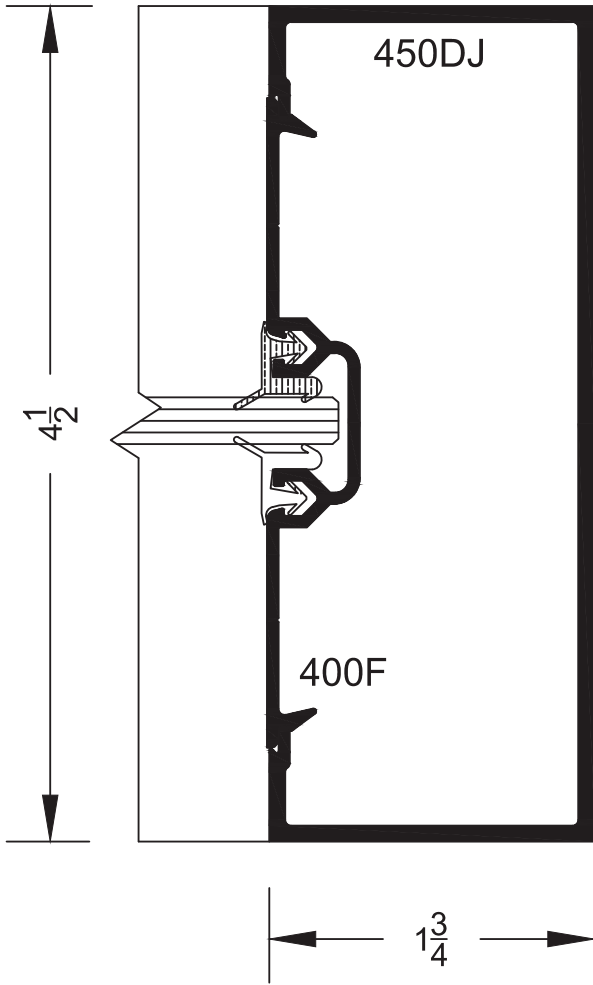

G-1

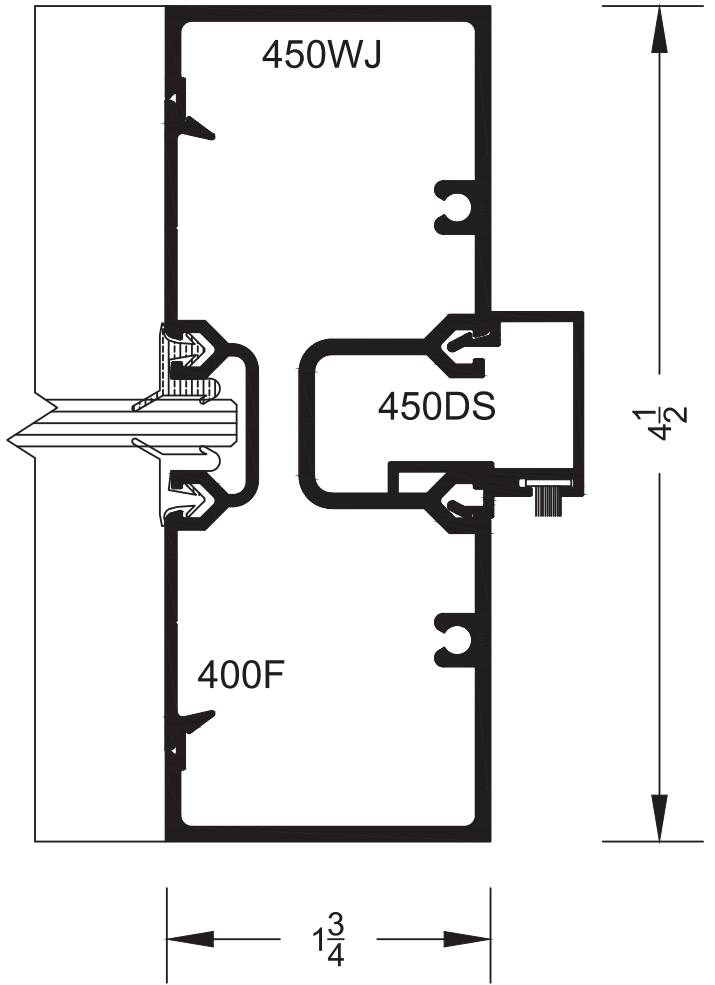

G-2

PL-450 SERIES
1-3/4 X 4-1/2
FULL SCALE



(K-1)

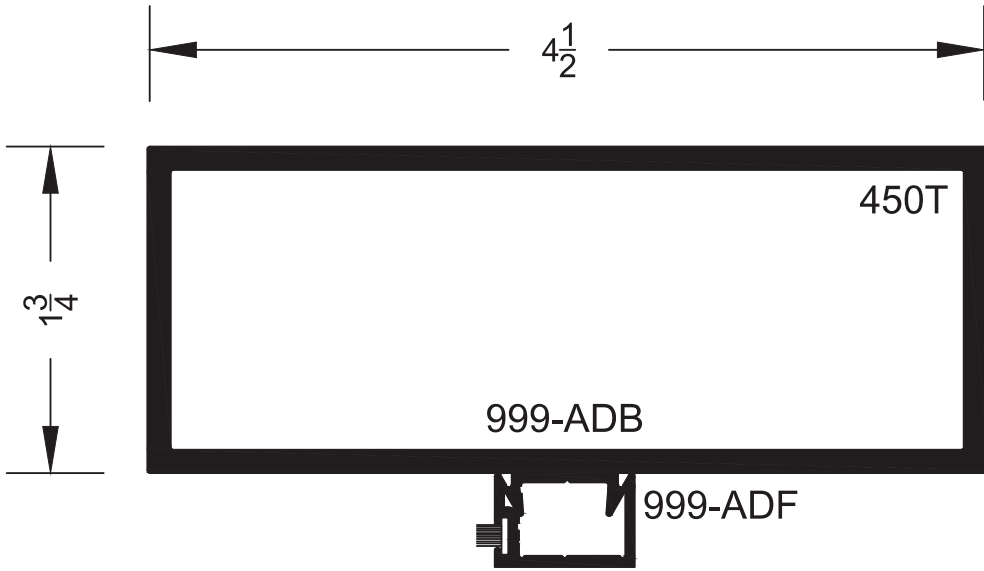

(K-2)

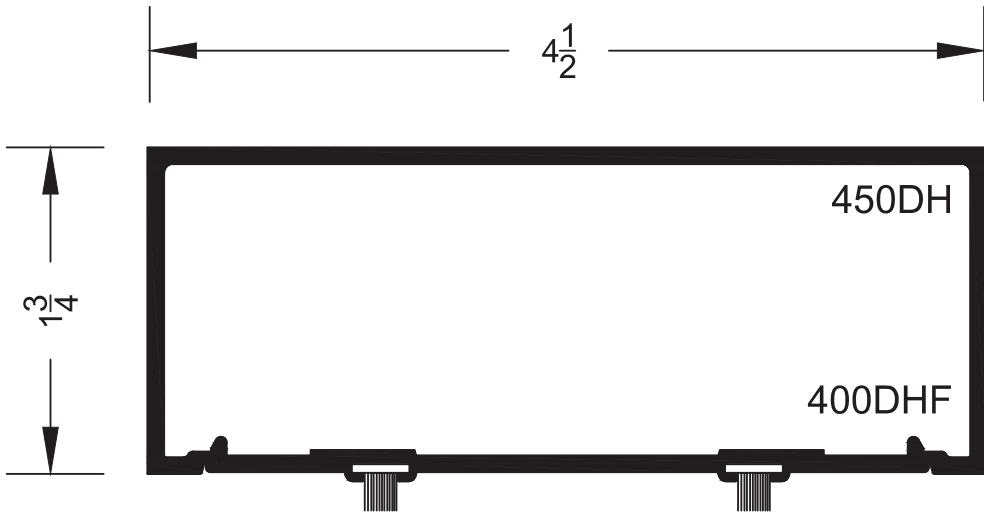

PL-450 SERIES
1-3/4 X 4-1/2
FULL SCALE



K-3

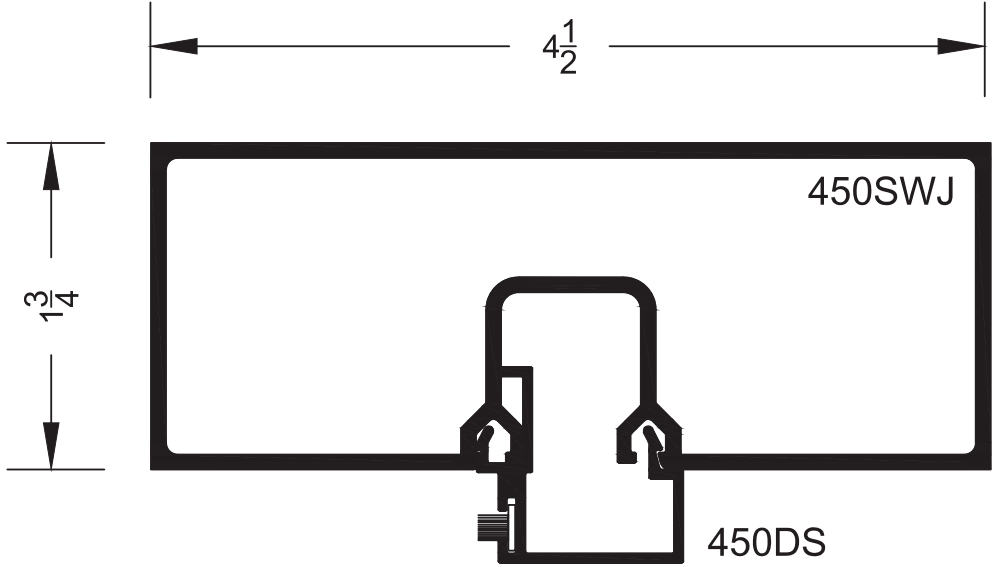

K-4

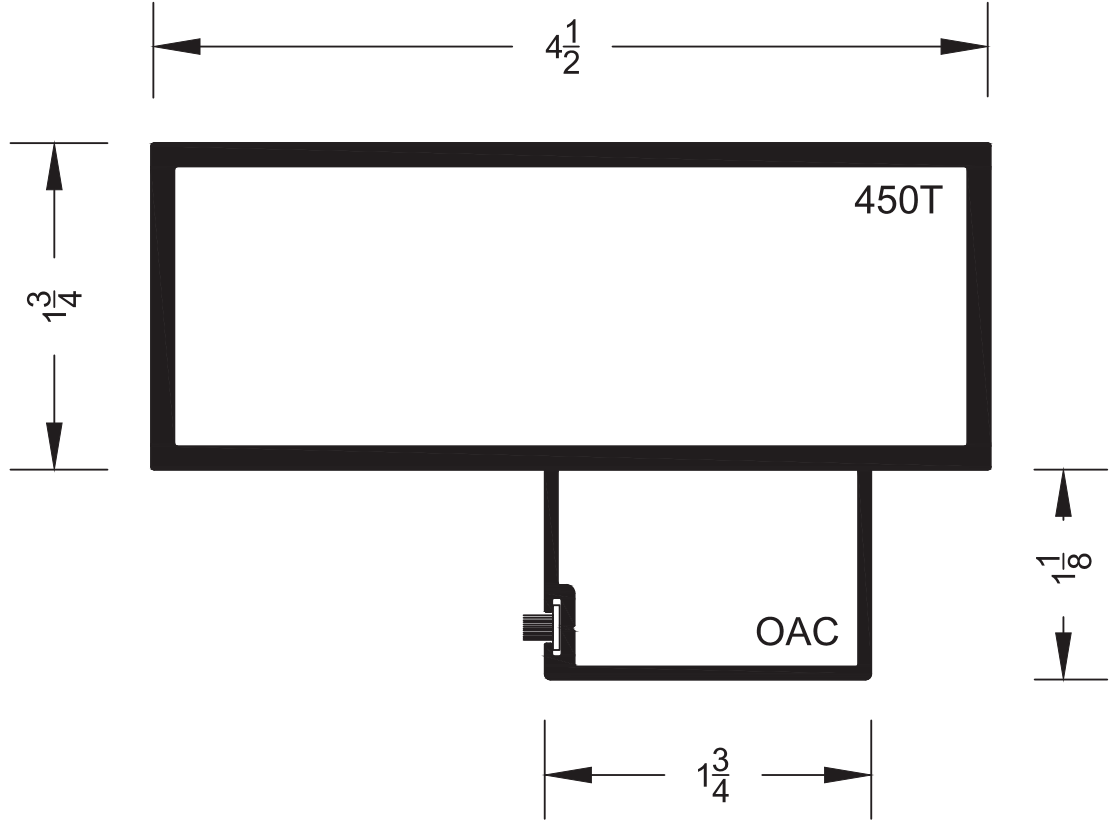

PL-450 - 15

ph: (877) 775-2586
fx: (877) 274-8800

14760 Don Julian Rd.
Industry, CA 91746

www.prlaluminum.com
sales@prlaluminum.com



WIND LOAD DESIGN

GLAZING FRAMING SHALL BE DESIGNED NOT TO EXCEED L/175, RATIO
CURVES SHALL REPRESENT LIMIT.

VALUES ARE BASED ON CRITERIA FOR SIMPLE BEAM UNIFORMLY LOADED.

ALLOWABLE STRESSES FOR 6063-T5 ALUMINUM ALLOY = 9500 P.S.I.
ALLOWABLE STRESSES FOR A-36 STRUCTURAL STEEL = 21600 P.S.I.

MAXIMUM DEFLECTION BETWEEN SUPPORTS FOR SINGLE SPAN:

$$\Delta = \frac{5WL^3}{384EI}$$

MAXIMUM BENDING MOMENT FOR SINGLE SPAN:

$$M = \frac{WL}{8}$$

NOTATIONS REPRESENT:

W = TOTAL UNIFORM LOAD

L = LENGTH OF MULLION BETWEEN SUPPORTS

E = 10×10^6 P.S.I.

I = MOMENT OF INERTIA OF MULLION

M = BENDING MOMENT

NOTE:

MULLIONS ARE ASSUMED TO HAVE EQUAL SIZE GLASS LIGHTS EACH SIDE

PL-450 SERIES
1-3/4 X 4-1/2
WIND LOAD



450 WALL JAMB WITH FILLER

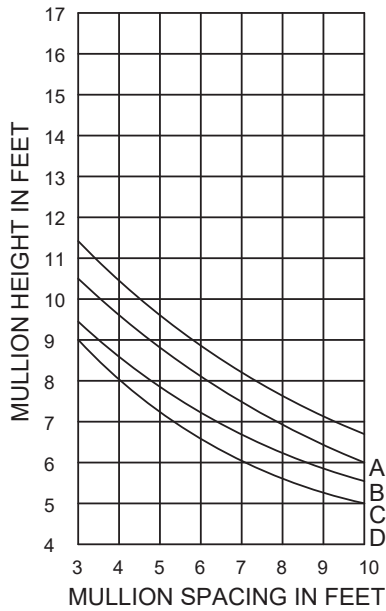

$I_{102} = 1.630 \text{ IN}^4$
 $S_{102} = 0.815 \text{ IN}^3$



450 WALL JAMB WITH STEEL REINFORCEMENT

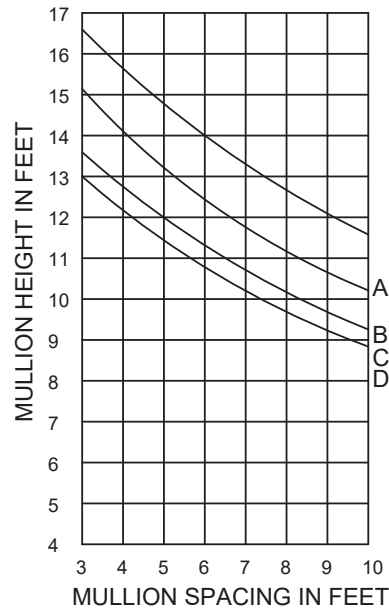

$I_{102/STL} = 4.642 \text{ IN}^4$
 $S_{102/STL} = 1.672 \text{ IN}^3$

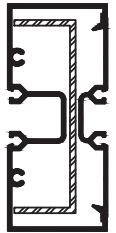

CURVE REPRESENTATION

A = 15 P.S.F. (75 M.P.H)
 B = 20 P.S.F. (90 M.P.H)
 C = 25 P.S.F. (100 M.P.H)
 D = 30 P.S.F. (110 M.P.H)

450 TUBE

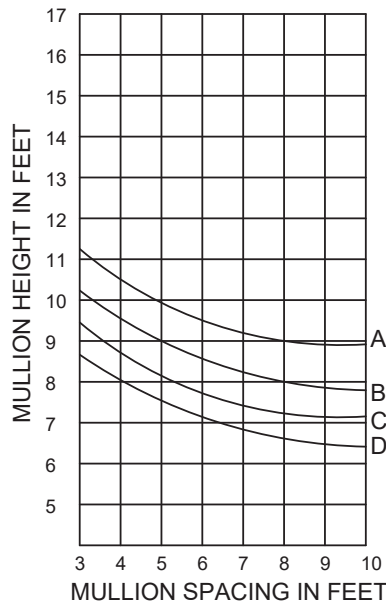

$I = 2.040 \text{ IN}^4$
 $S = 1.20 \text{ IN}^3$



450 TUBE WITH STEEL REINFORCEMENT

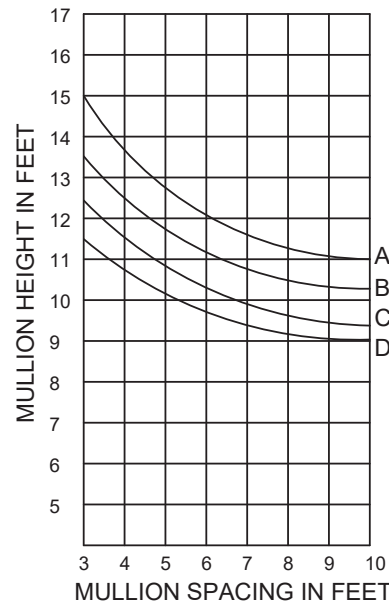

$I = 5.052 \text{ IN}^4$
 $S = 2.526 \text{ IN}^3$

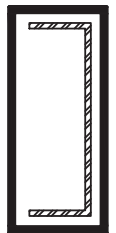

PL-450 SERIES
1-3/4 X 4-1/2
WIND LOAD



450 WALL JAMB WITH FILLER

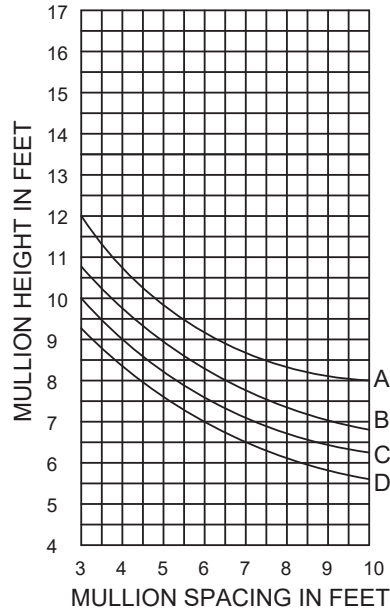

$I = 2.528 \text{ IN}^4$
 $S = 1.124 \text{ IN}^3$



CURVE REPRESENTATION
 A = 15 P.S.F. (75 M.P.H)
 B = 20 P.S.F. (90 M.P.H)
 C = 25 P.S.F. (100 M.P.H)
 D = 30 P.S.F. (110 M.P.H)

450 WALL JAMB WITH FILLER WITH STEEL REINFORCEMENT

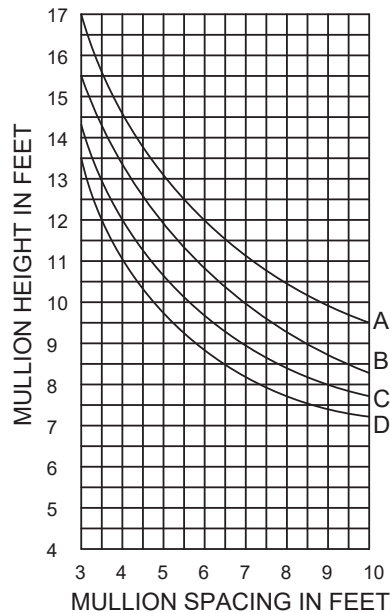

$I = 7.688 \text{ IN}^4$



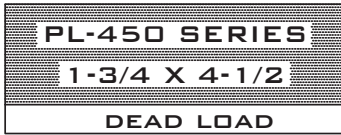

DEAD LOAD DESIGN

GLAZING FRAMING SHALL BE DESIGNED NOT TO EXCEED L/360 OR 1/8" DEFLECTION WHICHEVER IS LES, RATIO CURVES SHALL REPRESENT LIMIT.

VALUES ARE BASED ON CRITERIA FOR SIMPLE BEAM UNIFORMLY LOADED.

ALLOWABLE STRESSES FOR 6063-T5 ALUMINUM ALLOY = 9500 P.S.I.
ALLOWABLE STRESSES FOR A-36 STRUCTURAL STEEL = 21600 P.S.I.

MAXIMUM DEFLECTION BETWEEN SUPPORTS FOR SINGLE SPAN:

$$\Delta = \frac{Pa}{24EI} (3L^2 - 4a^2)$$

MAXIMUM BENDING MOMENT FOR SINGLE SPAN:

$$M = Pa$$

NOTATIONS REPRESENT:

P = 1/2 GLASS LOAD

a = 1/4 OR 1/8 POINT OF SPAN (INCHES)

E = 10×10^6 P.S.I.

I = MOMENT OF INERTIA OF MULLION

L = LENGTH HORIZONTAL SPAN

PL-450 SERIES
1-3/4 X 4-1/2
DEAD LOAD



450 HORIZONTAL MULLION

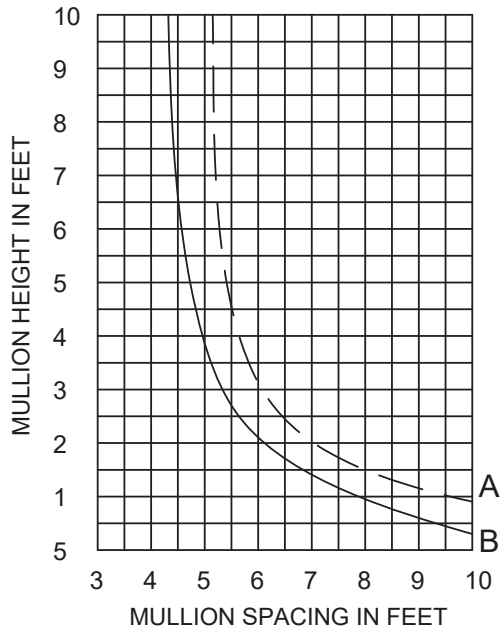

$I = 0.241 \text{ IN}^4$ MAX ALLOW DEFLECTION $L/360$
 $S = 0.250 \text{ IN}^3$ OR $1/8"$ WHICHEVER IS LESS

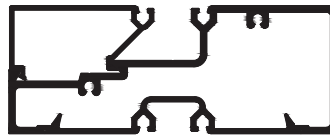

CURVE REPRESENTATION

(A) (- - - -) = 1/8 PTS. OR
A MINIMUM OF 8" AWAY
FROM THE EDGE OF GLASS

(B) (———) = 1/4 PTS.
A MINIMUM OF 8" AWAY
FROM THE EDGE OF GLASS